

South Dakota State University
**Open PRAIRIE: Open Public Research Access Institutional
Repository and Information Exchange**

Fact Sheets

SDSU Extension

8-4-2007

Grade A Milk Farm Production Requirements

Ervin Kurtz
South Dakota State University

Louis Lubinus

Follow this and additional works at: http://openprairie.sdstate.edu/extension_fact

Recommended Citation

Kurtz, Ervin and Lubinus, Louis, "Grade A Milk Farm Production Requirements" (2007). *Fact Sheets*. Paper 18.
http://openprairie.sdstate.edu/extension_fact/18

This Other is brought to you for free and open access by the SDSU Extension at Open PRAIRIE: Open Public Research Access Institutional Repository and Information Exchange. It has been accepted for inclusion in Fact Sheets by an authorized administrator of Open PRAIRIE: Open Public Research Access Institutional Repository and Information Exchange. For more information, please contact michael.biondo@sdstate.edu.

Farm Production Requirements

By Ervin Kurtz, Extension Dairyman, assisted by Louis Lubinus, Extension Agricultural Engineer, Cooperative Extension Service, South Dakota State University

Milking Barn, Stable, or Parlor

CONSTRUCTION

1. A milking barn, stable, or parlor shall be provided on all dairy farms.

2. Gutters, floors, and feed troughs to be constructed of good quality concrete or equally impervious material. Floors shall be easily cleaned (brushed surfaces permitted), shall be graded to drain, maintained in good repair and free of excessive breaks or worn areas that may create pools.

3. Walls and ceilings must be finished with wood, tile, smooth-surfaced concrete, cement plaster, brick, or other equivalent materials with light colored surfaces. Walls, partitions, doors, shelves, windows, and ceilings shall be kept in good repair; and surfaces shall be refinished whenever wear or discoloration is evident.

Whenever feed is stored overhead, ceilings shall be constructed to prevent the sifting of chaff and dust into the milking barn, stable or parlor. If a hay opening is provided from loft into the milking portion of the barn, such opening shall be provided with a dust-tight door which shall be kept closed during milking operations.

4. Bull pens, maternity and calf stalls, and horse stalls will be partitioned from the milking portion of the barn. Such portions of the barn that are not separated by tight partitions shall comply with all requirements of this section.

5. The milking barn shall be provided with natural and/or artificial light to insure that all surfaces and particularly the working areas will be plainly visible. The equivalent of at least 10 foot-candles of light in all working areas shall be provided.

6. Air circulation must be sufficient to minimize odors and to prevent condensation upon walls and ceilings.

7. Overcrowding is not evidenced by the presence of calves, cows, or other barnyard animals in walks or feed alleys. Inadequate ventilation and excessive odors may also be evidence of an overcrowded barn.

8. Dry feed storage rooms and silo approaches are to be separated from the milking portion of the barn by tight partitions. Direct openings into the milking barn shall have tight-fitting doors which are kept closed. Metal or wooden feed storage containers shall be of tight construction with dust-tight covers.

Milking Barn, Stable, or Parlor

CLEANLINESS

1. The interior of the milking barn, stable, or parlor is to be kept clean.

2. Leftover feed in feed mangers must appear fresh and not wet or soggy.

3. The bedding material, if used, should not contain more manure than has accumulated since the previous milking.

4. Outside surfaces or pipeline systems located in the milking barn, stable, or parlor are to be reasonably clean.

5. Gutter cleaners to be reasonably clean.

6. All pens, calf stalls, and bull pens, if not separated from the milking barn, stable, or parlor, shall be kept clean.

7. Swine and fowl are to be kept out of the milking barn.

Cowyard

1. The cowyard, which is the enclosed or unenclosed area adjacent to the milking barn, in which the cows may congregate, including cattle-housing areas and feedlots, is to be graded and drained; depressions and soggy areas filled; cow lanes reasonably dry.

2. Approaches to the barn door and the surroundings of stock watering and feeding stations shall be solid to the footing of the animal.

3. Wastes from the barn or milkhouse shall not be allowed to pool in the cowyard. Cowyards which are muddy due to recent rains shall not be considered as violating this item.

4. Manure soiled bedding and waste feed are not to be stored or

permitted to accumulate therein in such a manner as to permit the soiling of cows' udders and flanks. Cattle-housing areas (stable without stanchions, such as loose-housing stables, pen stables, resting barns, holding barns, loafing sheds, wandering sheds, free-stall housing) shall be considered as part of the cowyard. Manure packs shall be solid to the footing of the animal.

5. Cowyards to be kept reasonably free of cattle droppings. Cattle droppings shall not be allowed to accumulate in piles that are accessible to the animals.

Milkhouse or Room

CONSTRUCTION AND FACILITIES

1. A separate milkhouse of sufficient size must be provided for the cooling, handling, and storing of milk and the washing, sanitizing, and storing of milk containers and utensils.

2. The floors of all milkhouses to be constructed of good quality concrete (float finish permissible), or equally impervious tile, or brick laid closely with impervious material, or metal surfacing with impervious joints, or other material the equivalent of concrete and maintained free of breaks, depressions, and surface peelings.

3. The floor shall slope to drain so that there are no pools of standing water. The joints between the floor and the walls shall be watertight.

4. The liquid wastes are to be disposed of in a sanitary manner; all floor drains are accessible and are trapped if connected to a sanitary sewer.

5. Walls and ceilings to be constructed of smooth dressed lumber or similar material, well painted with a light-colored washable paint, and in good repair. Surfaces and joints shall be tight and smooth. Sheet metal, tile, cement block, brick, concrete, cement plaster, or similar materials of light color may be used; the surfaces and joints shall be smooth.

6. A minimum of 20 foot-candles of light shall be provided at all working areas from natural and/or artificial light for milkhouse operations.

7. Windows and solid doors to be closed during dusty weather.

8. The milkhouse shall be adequately ventilated to minimize odors and condensation on floors, walls, ceilings, and clean utensils.

9. Vents, if installed, and lighting fixtures are to be located to preclude the contamination of bulk milk tanks or clean utensil storage areas.

10. The milkhouse can not be used for purposes other than milkhouse operations.

11. There shall be no direct opening into any barn, stable, or room used for domestic purposes; except that an opening between the milkhouse and milking barn, stable, or parlor is permitted when a tight-fitting self-closing solid door(s) hinged to be single or double acting is provided.

12. A vestibule shall be used into a barn and must comply with the applicable milkhouse construction requirements. A vestibule is not required leading into a parlor.

13. The transfer of milk from a bulk-holding/cooling tank to a transport tank is to be through a hose port located in the milkhouse wall. The port shall be fitted with a tight door, which shall be in good repair. It shall be kept closed except when the port is in use.

14. Water under pressure shall be piped into the milkhouse.

15. Each milkhouse must be provided with facilities for heating water in sufficient quantity and to such temperatures for the effective cleaning of all equipment and utensils.

16. The milkhouse to be equipped with a wash-and-rinse vat having at least two compartments. Each compartment must be of sufficient size to accommodate the largest utensil or containers used. The cleaning-in-place vat for milk pipelines and milk machines may be accepted as one part of the two-compartment vat: provided, that the cleaning-in-place station rack in or on the vat and the milking machine inflations and appurtenances are completely removed from the vat during the washing, rinsing, and/or sanitizing of other utensils and equipment.

17. A suitable shelter shall be provided for a transportation truck used for cooling and storing milk. Such shelter shall be adjacent to, but not a part of, the milkroom and shall comply with the requirements of the milkroom with respect to construction, light, drainage, insect and rodent control, and general maintenance.

Milkhouse or Room CLEANLINESS

1. The milkroom structure, equipment, and other milkroom facilities used in its operation or maintenance are to be clean at all times.

2. Insecticides, rodenticides, antibiotics, medicinals, etc. shall not be stored in the milkroom.

3. Vestibules, if provided, shall be kept clean.

4. Animals and fowl will be kept out of the milkroom.

Toilet

1. There shall be at least one flush toilet connected to a public sewer system or to an individual sewage-disposal system or a chemical toilet, earth pit privy, or other type of privy. Such sewerage systems shall be constructed and operated in accordance with plans and instructions of the State health authority.

2. A toilet or privy shall be convenient to the milking barn and the milkroom. There shall be no evidence of human defecation or urination about the premises.

3. No privy will open directly into the milkroom.

4. The toilet room, including all fixtures and facilities, shall be kept clean and free of flies and odors.

5. Where flush toilets are used, doors to toilet rooms must be tight and self-closing. All outer openings in toilet rooms shall be screened or otherwise protected against the entrance of flies.

6. Vents of earth pits will be screened.

Water Supply

1. The water supply for milkhouse and milking operations shall be approved as safe by the State health authority.

2. No cross-connection shall exist between a safe water supply and any unsafe or questionable water supply, or any other source of pollution.

3. There are to be no submerged inlets through which a safe water supply may be contaminated.

4. The well or other source of water shall be located and constructed in such a manner that neither underground nor surface contamination from any sewerage systems, privy, or other source of pollution can reach such water supply.

5. New individual water supplies and water supply systems which have been repaired or otherwise become contaminated must be thoroughly disinfected before being placed in use. The supply shall be made free of the disinfectant by pumping to waste before any sample for bacteriological testing shall be collected.

6. All containers and tanks used in the transportation of water will be sealed and protected from possible contamination. These containers and tanks shall be subjected to a thorough cleaning and a bacteriological treatment prior to filling with potable water to be used at the dairy farm. To minimize the possibility of contamination of the water during its transfer from the potable tanks to the elevated or ground-water storage at the dairy farm, a suitable pump, hose, and fittings shall be provided. When the pump, hose and fittings are not being used, the outlets shall be capped and stored in a suitable dustproof enclosure so as to prevent their contamination. The storage tank at the dairy farm shall be constructed of impervious material provided with a dust and rainproof cover, and also provided with an approved-type vent and roof hatch. All new reservoirs or reservoirs which have been cleaned shall be disinfected prior to placing them into service.

7. Samples for bacteriological examination are to be taken upon the initial approval of the physical structure based upon the requirements and when any repair or alteration of the water supply system has been made: provided, that when water is hauled to the dairy farm such water shall be sampled for bacteriological examination at the point of use and submitted to a laboratory each month. Bacteriological examinations shall be conducted in a laboratory acceptable to the health authority.

8. Current records of water test results must be retained on file with the health authority or as the health authority directs.

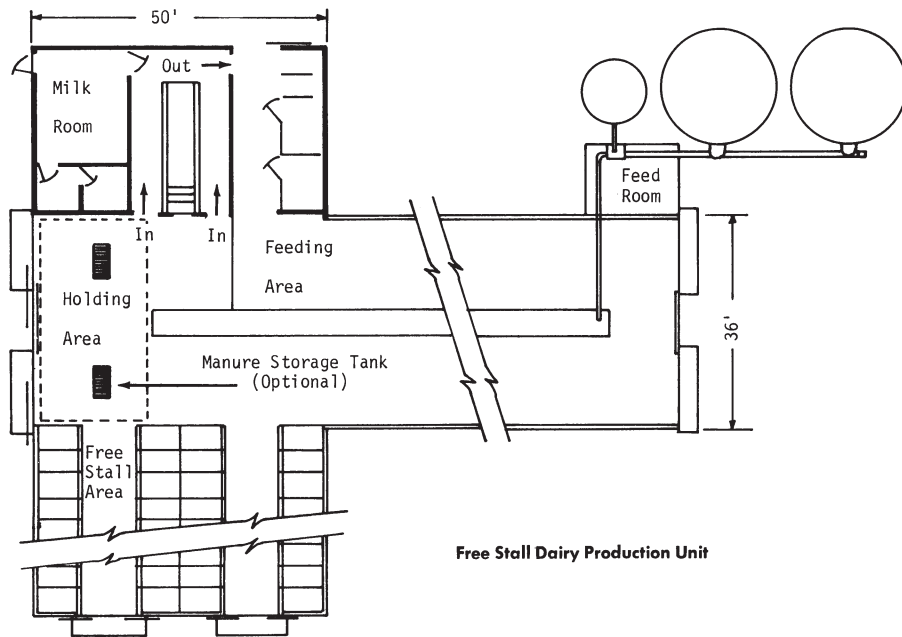

Free Stall Dairy Production Unit

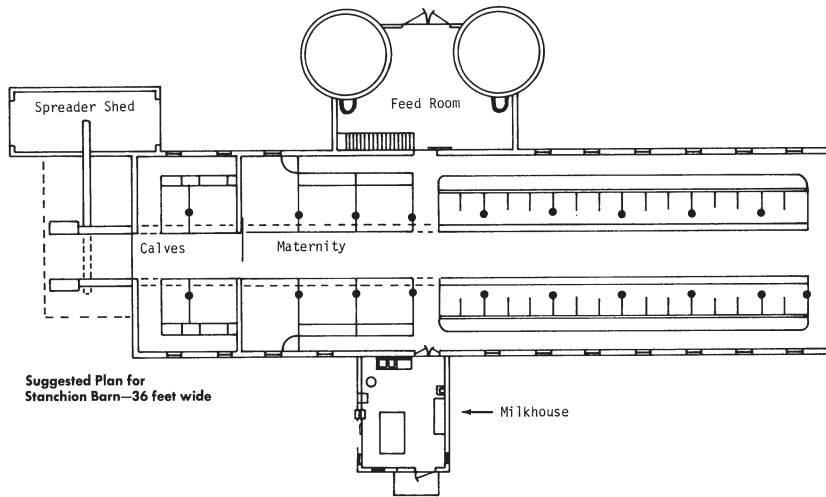

Suggested Plan for Stanchion Barn—36 feet wide

Milking Plant

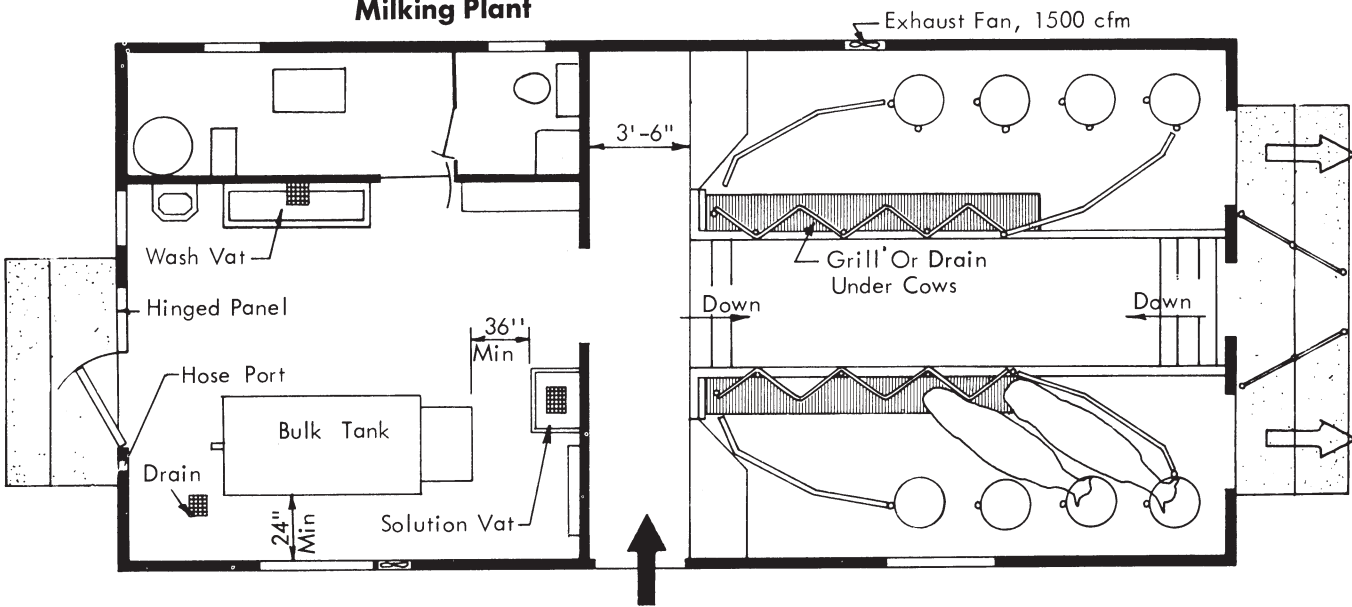

Milk Room Guidelines Recommendations for Size

Herd size	Dimensions (feet)
25 to 50	14x18
50 to 100	16x22
100 and above	18x28

BULK TANK CAPACITY

Hold five milkings at peak production for every other day pickup.

Working space around tank:

- 24 inches from rear and side.
- 36 inches from outlet valve and working side.

LOADING PLATFORM

4x8-foot concrete or slab on grade. Provide self-closing hose port for bulk pickup trucks.

FLOORS AND DRAINS

Slope: $\frac{1}{4}$ inch per foot to drain.

Drain location:

- All floor surfaces within 12 feet of drain.
- Drain under wash vats.
- Drain 24 inches from bulk tank outlet valve.

LIGHTING AND WIRING

Window glass area: equal to 10% of floor area.

Swivel lights to light inside bulk tank. Light over wash vat and loading platform.

Outlets for all machines used.

Ground conductors to all electric equipment.

Water Supply Guidelines

Before installing new water or sewage facilities contact your plant fieldman to approve your plans. The following general regulations normally apply:

WELL LOCATIONS

Locate a new well at least 100 feet from cesspools or sewage leaching pits. Allow 50 feet between the well and a septic tank, outside toilet, manure pile, and unpaved feedlots where manure accumulates. No sewage disposal line should run within 10 feet (measured horizontally) of a well. If such a line runs more than 10 feet but less than 50 feet from a well, it must be cast iron and have leaded joints. All surface drainage must slope away from the well area. Provide a fill if natural drainage does not exist.

A sealed well casing must extend from at least 10 feet below ground surface to at least 6 inches above the well platform. Install a concrete slab,

at least 4 feet square, around the well casing. Have the surface of the slab slope away from the well.

No pit or unfilled space may be within 10 feet (measured horizontally) of the well. This requirement does not apply to a residential basement which may be located closer to a driven or drilled water supply.

PUMP LOCATION

Install a pneumatic pressure water system—don't install any pump or pumping equipment in a pit. An approved pitless unit or placing the pump and equipment in an insulated above-ground pumphouse is recommended. You may place the pressure tank of a pitless unit in the house basement or other similar location. But don't install the pump in a below-ground room or pit off the house basement. And don't store other materials in an above-ground insulated pumphouse or other pump enclosure.

The base plate of a pump placed immediately over the well should form a watertight seal with the well casing.

PIPING

You may use plastic, galvanized iron, or copper piping. If the pump is offset from the well, no suction pipe (all shallow well pumps and inlet pipes on jet pumps) should contact the earth. Install all such piping inside a watertight casing. In a two-pipe system, one inside the other, attach the outer pipe to the pressure side and the inner pipe to the suction side of the pump.

Don't locate a water pipe within 10 feet (measured horizontally) of any sewer, drain, or other pipe that carries polluted water unless: (1) the bottom of the water pipeline is above the top of the sewer line, (2) the water line is placed on a solid shelf excavated to one side of the common trench, or (3) parts of the sewer line lying within 10 feet of the water line are of cast iron with leaded joints or the equivalent.

Utensils and Equipment

CONSTRUCTION

1. The milk-contact surfaces of all multiuse containers, utensils, equipment piping, and fittings shall be smooth and constructed of:

a. Stainless steel of the AISI (American Iron and Steel Institute) 300 series; or

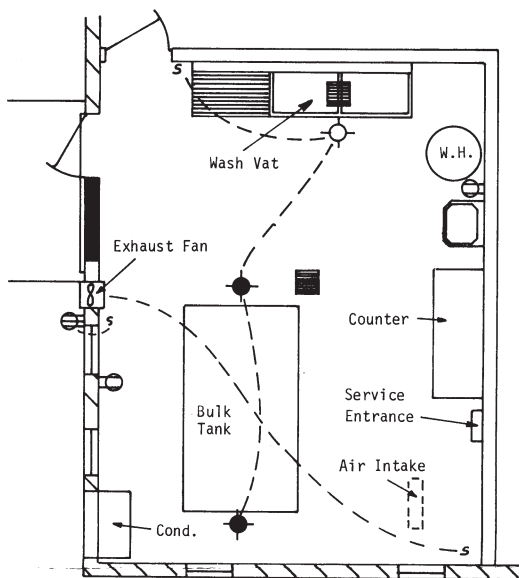

FLOOR PLAN FOR MILKROOM INSIDE OF BARN
(Plan No. 6063)

Legend

S	Single-Pole Switch	⊖	120 Outlet
S ₃	Three-way Switch	▨	Barn Wall
⊙	Light Bulb Outlet	▭	Milk House Wall
●	150 - Watt Flood Light	■	Removable Panel
⊖	240 Weatherproof Outlet	▧	Floor Drain

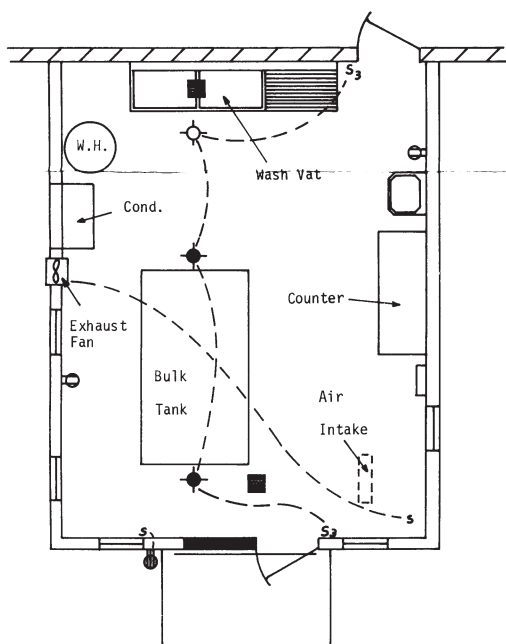

FLOOR PLAN FOR MILKROOM OUTSIDE BARN
(Plan No. 6063)

b. Equally corrosion-resistant, non-toxic metal; or

c. Heat-resistant glass; or

d. Plastic or rubber and rubberlike materials which are relatively inert, resistant to scratching, scoring, decomposition, crazing, chipping, and distortion, under normal use conditions; are nontoxic, fat resistant, relatively nonabsorbent, relatively insoluble, do not release component chemicals or impart flavor or odor to the product, and which maintain their original properties under repeated-use conditions.

2. Single-service articles are to have been manufactured, packaged, transported, stored, and handled in a sanitary manner.

3. Articles intended for single service use can not be reused.

4. All containers, equipment, and utensils shall be free of breaks and corrosion.

5. All joints in such containers, equipment, and utensils are to be smooth and free from pits, cracks, or inclusions.

6. Cleaned-in-place milk pipelines and return-solution lines shall be self-draining. If gaskets are used they shall be self-positioning and of material meeting specifications described in (1) (d) above, and shall be of such design, finish, and application as to form a smooth flush interior surface. If gaskets are not used, all fittings shall have self-positioning faces designed to form a smooth, flush interior surface. All interior surfaces of welded joints in pipelines shall be smooth and free of pits, cracks, and inclusions.

7. Detailed plans for cleaned-in-place pipeline systems shall be submitted to the health authority for written approval prior to installation. No alteration or addition shall be made to

any milk pipeline system without prior written approval of the health authority.

8. Strainers, if used, are to be of perforated metal design, or so constructed as to utilize single-service strainer media.

9. Seamless hooded pails having an opening not exceeding one-third the area of that of an open pail of the same size shall be used.

10. All milking machines, including heads, milk claws, milk tubing, and other milk-contact surfaces shall be easily cleaned and inspected.

11. Milk cans have umbrella-type lids.

12. Farm holding/cooling tanks, welded sanitary piping, and transportation tanks shall comply with the applicable requirements.

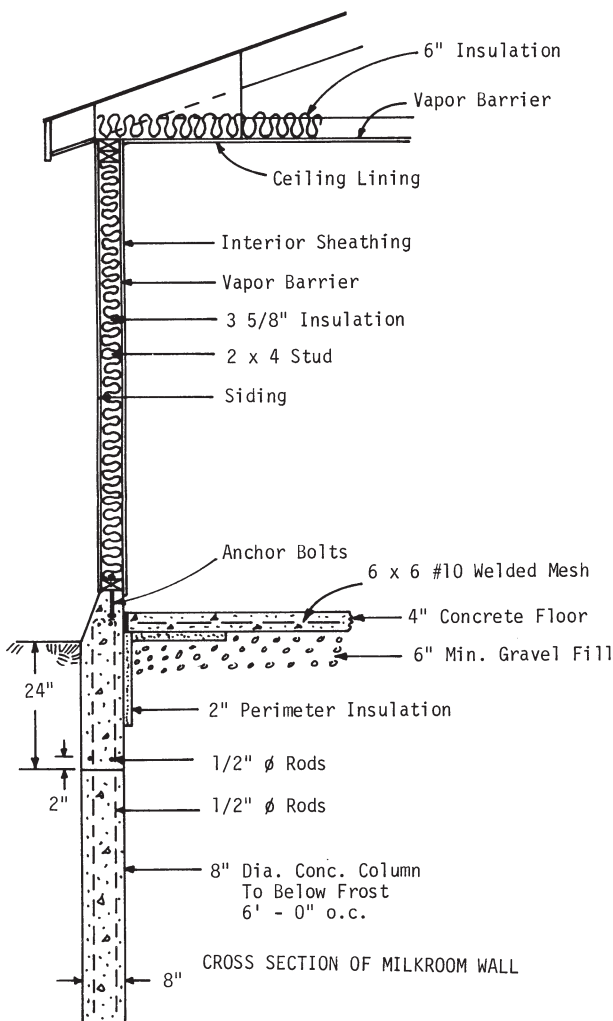

Floor Drains (not to scale)

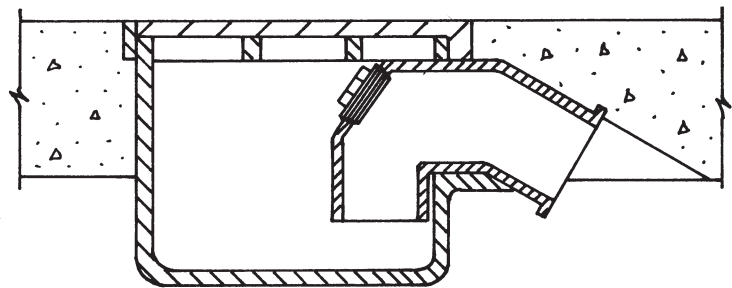

RECOMMENDED SIZE 8" x12"

BELL TRAP
FLOOR DRAIN
Recommended
size:
4" Discharge

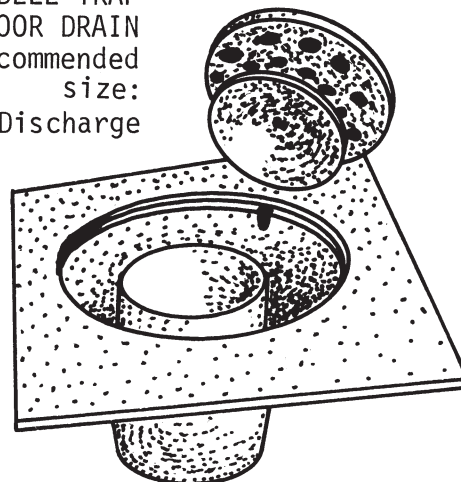

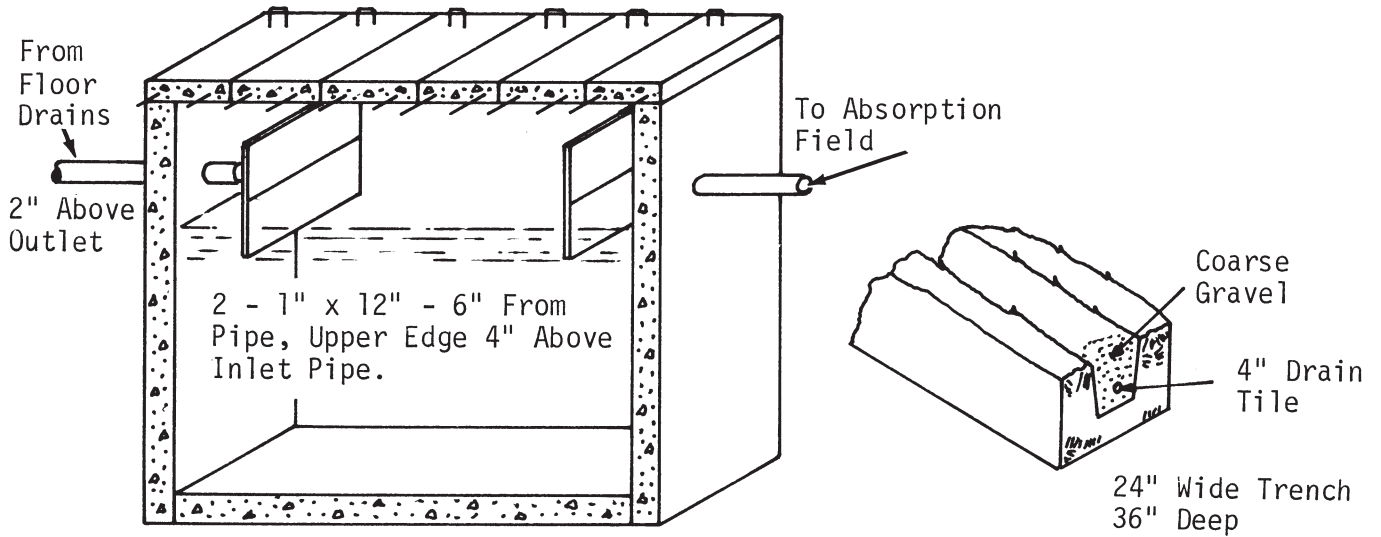

SETTLING TANK
(20 Gal. Per Cow)

ABSORPTION TRENCH

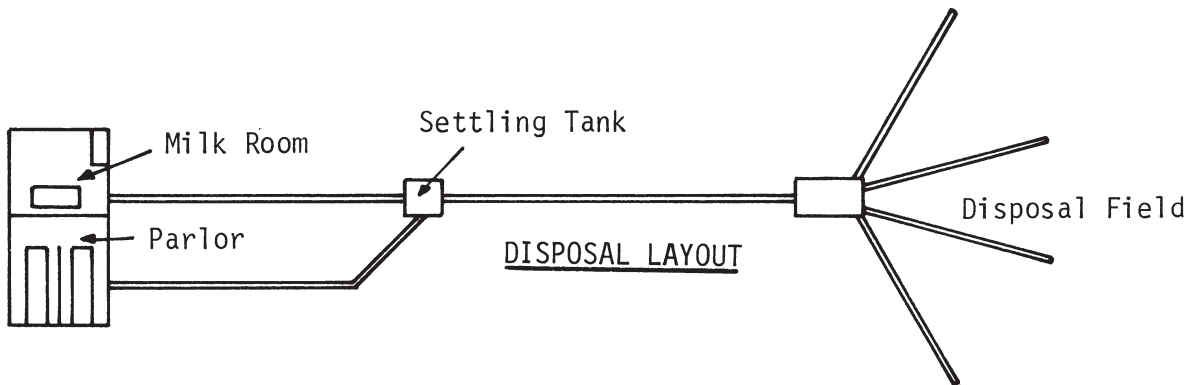

Issued in furtherance of Cooperative Extension work, acts of May 8 and June 30, 1914, in cooperation with the United States Department of Agriculture.
Duane Acker, Director of Extension, South Dakota State University, Brookings, 57006.
3M-7-72-File: 4.6-4178

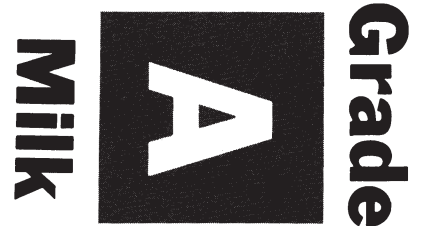

Farm Production Requirements

This publication can be used as a reference for remodeling or building dairy farm production units. It follows the recommendations of the United States Public Health Service but not in its entirety. For details consult the local Dairy Inspector of the State Department of Agriculture.

Cooperative Extension Service
South Dakota State University, Brookings
U. S. Department of Agriculture