

South Dakota State University  
**Open PRAIRIE: Open Public Research Access Institutional  
Repository and Information Exchange**

---

SDSU Extension Circulars

SDSU Extension

---

12-1956

## You Can Get More Eggs

Boyd Bonzer

Lloyd Shinnick

Follow this and additional works at: [http://openprairie.sdstate.edu/extension\\_circ](http://openprairie.sdstate.edu/extension_circ)

 Part of the [Agriculture Commons](#)

---

### Recommended Citation

Bonzer, Boyd and Shinnick, Lloyd, "You Can Get More Eggs" (1956). *SDSU Extension Circulars*. 672.  
[http://openprairie.sdstate.edu/extension\\_circ/672](http://openprairie.sdstate.edu/extension_circ/672)

This Circular is brought to you for free and open access by the SDSU Extension at Open PRAIRIE: Open Public Research Access Institutional Repository and Information Exchange. It has been accepted for inclusion in SDSU Extension Circulars by an authorized administrator of Open PRAIRIE: Open Public Research Access Institutional Repository and Information Exchange. For more information, please contact [michael.biondo@sdstate.edu](mailto:michael.biondo@sdstate.edu).





**you can get more eggs**

A GUIDE FOR RAISING AND  
MANAGING THE LAYING  
FLOCK IN SOUTH DAKOTA

AGRICULTURAL EXTENSION SERVICE  
SOUTH DAKOTA STATE COLLEGE  
U. S. DEPARTMENT OF AGRICULTURE



# You Can Get More Eggs

By

Boyd Bonzer and Lloyd Shinnick  
Extension Poultrymen

## Planning the Poultry Project

One of the most common causes of lost profits and failure in poultry keeping is the lack of planning and foresight. A good poultryman is alert and wide awake; he is a person who spends a lot of time with small details—one who can watch his birds and sense when they start to get sick or go out of condition. He is a person who plans ahead and is prepared for the different phases of poultry management as the birds grow and mature.

### Consider Facilities

When planning a poultry project, one should consider the different stages the birds will go through as they mature and be sure he has adequate facilities to properly care for the birds. It will be necessary to have space for brooding, a place to put the birds out on range on clean ground and laying house space to house the birds when they come into production.

Much of the equipment can be constructed on the farm by anyone who is handy with a saw and hammer. Figure 7 shows a range shelter that can be built. Fig. 6 is a feeder for the laying house. Fig. 5 shows an automatic water fountain that can be used in the brooder house, on the range and in the laying house. Building some of the equipment will save money and gives one a more personal interest in the project.

### What Chicks To Buy

The purpose of the poultry project will help determine the breed of birds to buy.

Sexed pullets of good egg production strains of Leghorns or Leghorn crosses or hybrids should be purchased if the project is primarily for market egg production. Good egg producing strains of Plymouth Rocks, New Hampshires, heavy crosses or heavy hybrids should be purchased if the project is aimed at producing poultry meat as well as eggs.

A broiler project will require a good broiler strain of bird that has been bred for meat production.

Buy baby chicks that are bred to produce the thing you want, be it eggs, meat or both meat and eggs.

### Where to Buy Chicks

Buy chicks from a reliable hatchery near home. Many cases of disease in baby chicks have been traced to long shipments on trains or trucks. Such diseases as Newcastle and bronchitis are airborne and will spread from the boxes of sick chicks to healthy chicks when they are stacked near each other in shipment. Chicks picked up at the local hatchery with the family car have no contact with chicks from other places and will be as free of

disease when you get them home as they were when they left the hatchery. If the hatcheryman is near he can be contacted easily if chicks are diseased when you receive them.

A reliable hatcheryman is one who sells chicks that are strong and healthy. He is one that carries on a good breeding program in his supply flocks and one who practices an intense blood testing program to eliminate pullorum and Typhoid disease in the hatching egg supply flocks.

A reliable hatcheryman will stand behind his chicks and provide replacements if unusual death losses occur.

### How Many Chicks to Buy

Two and one-half straight run chicks should be purchased for each pullet that will be housed in the fall. If sexed pullets are purchased one and one-fourth pullets should be brooded for each mature pullet to be housed in the fall.

In a broiler flock a 5% death loss is considered high. It will not be necessary to buy very many more chicks than one plans to market for broiler project.

Sexed heavy-breed cockerels are a good buy for a broiler project. Cockerels will grow a little faster than pullets and will produce a little more meat on the same amount of feed. Larger broiler projects use straight run chicks.

### When to Start Chicks

March and April are the months to start chicks for a laying flock. They will produce early fall eggs. Heavy breeds should be in good production when they are between five and six months old; light breeds should be in good production about a month sooner.

Egg prices are usually the highest during the last four months of the year. (Sept., Oct., Nov. and Dec.) A project that is directed toward egg production should produce as many eggs during these months as possible.



Fig. 1. Place feeders and water fountains around the stove like spokes in a wheel. Note heavy paper around corners of house.



## Managing and Feeding Chicks

The first few weeks are critical in the baby chick's life. Chicks that get a good start have a better chance of developing into strong, healthy pullets and cockerels.

The brooder house and equipment should be thoroughly cleaned and disinfected and things put in order several days before the baby chicks arrive.

### Clean and Disinfect House

Cleaning and disinfecting of the house and equipment should be done before the brooder house is moved to clean ground. This keeps the contamination from spreading to the new ground where the chicks will be allowed to run.

First remove all equipment such as stove, feeders, roosts, etc., and brush down the walls and ceiling with a broom.

Next clean and scrape the floor, being sure to get all the caked litter loose. A garden push hoe is a handy gadget for scraping the floor. Scrub the floor and lower walls with boiling hot lye water (1 lb. of household lye to 30 gallons boiling water). It is important to do a thorough job of scrubbing as a dirty surface can not be disinfected.

Now the house is ready to be disinfected. All parts of the inside of the house should be thoroughly soaked by spraying or brushing with a commercial disinfectant mixed according to the manufacturer's directions, or a solution of 5 tablespoons of lysol per gallon of hot water.

### Clean and Disinfect Equipment

Feeders, roosts and other equipment to be used in the house require the same thorough cleaning and disinfecting as the house. Allow them to dry in the sun.

A wide putty knife and stiff scrub brush are handy tools when cleaning small equipment.

Caution should be used when working with boiling lye water as it will irritate the skin. A pair of rubber gloves will protect the hands. Rinse with plenty of clean water if any is splashed on the skin or in the eyes.

### Ready the House for the Chicks

Move the brooder house to clean grounds where no poultry has been allowed to run for at least one year, two years if possible.

A permanent brooder house that cannot be moved should be provided with a sun porch.

The brooder stove should be set up and started at least three days before the chicks arrive. This gives the house a chance to dry out and the stove can be regulated so it will hold an even temperature (95°F at edge of hover, 2 inches above the litter). Any worn or broken parts should be replaced when the stove is started. An improperly regulated stove will result in overheated or chilled chicks and often causes disastrous results. When the floor is dry, spread litter three or four inches deep. There are many good types of litter that can be used. Corn cobs ground to about the size of a walnut, cotton seed hulls, peat moss, sugar cane fiber, chalk rock, and chopped straw are all very successful litter. Brooder house litter should be rather fine and easy to stir. The droppings will mix



Fig. 2. Chicks should be encouraged to roost when they are three weeks old. Covering the roosting section with 1x2-inch welded wire on the under side will keep the chicks away from the droppings that accumulate under the roost.

Fig. 3. Sunporches can be used when it is necessary to use the brooder house as permanent housing. The floor of the porch can be constructed of either 1 x 4-inch welded wire or 1-inch wood slats spaced 1 inch apart. Framework can be either steel or wood. Feed and water should be supplied on the sunporch.

with a fine litter rather than mat on top as they will with long straw.

Placing of feeders and waterers will be determined somewhat by the type of brooder stove in use.

Oil brooders heat the area under the hover and will raise the room temperature of the house. Feeders and water fountains should be placed around the stove in the form of spokes in a wheel. (See Fig. 1.)

Bottle gas brooders heat, primarily, below the hover but also throw some heat out to the rest of the house. Some feeders and water fountains should be placed under the hover the first three or four days so the chicks will be able to eat and drink without going out in the colder temperatures away from the hover.

Electric brooders heat only the area below the hover. Put the feeders under the curtain, half out of the hover. Place some quart waterers under the hover for the first few days until the chicks start using those around the hover. During cold weather many chicks will never leave the hover until they get a few days old.

Heat bulbs warm only what they shine on. Place feed and water near the bulb area. Bulbs are sometimes used in connection with electric and gas brooders.

Be sure to follow manufacturer's recommendations with the type of stove in use. Do not overcrowd the unit. An oil brooder with 60 inch hover, a gas brooder with



## A Handy Brooding Guide

Table I reproduced through courtesy of Poultry Tribune

Age	First Week	Two to Four Weeks	Four to Eight Weeks	Eight to Twelve Weeks
Brooding Temperature	Before chicks arrive operate brooder stove at least a week at temperature recommended by manufacturer—usually 90° F. with thermometer at edge of the hover and 2 inches above litter—under hover in case of electric brooders. Winter brooding may require slightly higher temperatures.	Use manufacturer's directions. The usual recommendations are to reduce temperature 5 to 10 degrees per week until about 70 degrees F. is reached. A better guide to proper temperature is to regulate brooder to temperature at which chicks appear to be most comfortable. If temperature is correct, chicks will form a ring at night about six inches away from the edge of the hover, or spread out evenly under electric hovers.		In most instances, heat is entirely discontinued about sixth week. In brooding chicks in extremely cold weather, it may be necessary to provide a little heat to prevent crowding and piling.
Type of House and Space Required for Floor Brooding	Use a well-built, easily ventilated house of standard type. Allow at least one-half square foot of floor space per chick. Regardless of floor space available, do not brood more than 300 to 350 chicks under one hover. With conventional type brooder, allow 7 sq. in. floor area per chick under hover. When a large room with central heating system is used, there should be not more than two chicks per square foot of floor area up to eight weeks of age.		Not later than sixth week, separate cockerels from pullets and move cockerels to another house. If growing chickens are confined to house (no range) allow 1 sq. ft. floor space per bird.	If clean range is available, move birds to range. Provide one 10 by 10 ft. range shelter (or equivalent of other dimensions) for each 125 birds.
Space Required for Battery Brooding	Use manufacturer's directions. In most instances 10 sq. in. tray space per chick.	Use manufacturer's directions. In most instances, 20 sq. in. tray space per chick.	Use manufacturer's directions. In most instances, 30 sq. in. per chick to 6 weeks and 40 sq. in. to 8 weeks.	Use manufacturer's directions. In most instances, 55 sq. in. per chick 9 to 10 weeks and 75 sq. in. thereafter.
Feeding Program	Have feeders well filled with a good starting mash when chicks are placed in the brooder. Do not starve chicks—feed them as soon as possible. Adopt a feeding program recommended by a well-known commercial feed company, agricultural college or other approved agency and follow this program exactly as directed. Fine grit should be provided. Fine chick grain, given as the only feed the first two days, may help prevent "pasting up."		Continue with approved feeding program as recommended. Grain feeding is usually started at 4 to 6 weeks, but specifications of feeding program used should be followed. Continue grit. Supply green feed or green range if available.	
Feeding Equipment	Provide one linear inch feeder space per chick with simple, durable waste-proof feeders that are easy to clean and fill. In addition, place feed in shallow pans, box lids, or egg case flats, where chicks can find it easily for the first few days. If automatic feeders are used, follow the manufacturer's recommendations.		Not later than fifth week, change from small chick type feeders to larger ones of proper construction for larger birds. Provide 2 to 2½ linear in. feeder space per chick.	Change to range type feeders providing one 5 ft. mash feeder (or equivalent) and a grain feeder of similar size for each 100 to 125 pullets.
Water Supply	Provide at least two one-quart fountains (or equivalent in other types of fountains) for each 100 chicks. Use sanitary fountains that are easy to clean and fill. At the end of ten days to two weeks, change to larger fountains. They will save labor. One 5-gallon fountain will take care of 200 chicks. Automatic water fountains can be used after the chicks are a week to 10 days of age to maturity.		Continue to use larger fountains. As the chicks grow, raise fountains on blocks or put them on wire platforms to prevent litter getting into water.	When chicks are moved to range, supply range type watering equipment. Many types and styles are available. Use equipment that will keep plenty of clean water available constantly.
Miscellaneous Equipment	Use chick guard made of paper or other material to encircle the brooder, keeping chicks near heat, feed and water. Move back gradually and remove entirely by the end of a week.	Place feeders and fountains on slatted or wire covered platforms. If house is square, round out corners by tacking metal or wood strips across corners. Install low roosts at from three to six weeks of age.	Continue use of wire or slatted platform—use larger ones if necessary. Paint wood with creosote or carbolineum yearly at least 3 or 4 weeks before the equipment is used for chicks. Some place range feeders and fountains on a platform having skids or runners for convenience in moving. Increase roosting space as needed to avoid crowding.	
Litter	Absorbent litters, such as peat moss, cane fibre, mineral litter, or cottonseed, rice, oat, or peanut hulls reduce labor requirements as they can be kept dry by stirring them frequently and need not be replaced until they get damp. As a general rule, start with a layer of litter 3 or 4 inches deep and do not add more unless some must be removed because of dampness. Less absorbent litters, such as straw, are fairly satisfactory if free from mold and if they are changed frequently to keep dry.			Range shelters are usually equipped with wire floors, or a slatted floor made of planed 1" x 1" strips of wood, preferably a hard wood, can be used as a substitute for wire.
Wire Flooring	Wire fabrics sometimes are used for brooder house floors. Any ⅜ to ¾ inch mesh welded wire fabric, hardware cloth or hexagonal netting, 15 to 18 gauge will be satisfactory. All of these are too large for baby chicks, so for starting chicks, such floors must be covered with paper and litter. Most chicks are brooded on litter, of course, and wire floors are used mainly in batteries and in range shelters.			For heavier birds and for floors in range shelters, 1 x 2 in., 14 gauge or 1 inch mesh, 16 gauge hexagonal netting is used. When neither is available, a slatted floor made of planed 1" x 1" strips of wood, preferably a hard wood, can be used as a substitute.
Sanitation	Four weeks before chicks arrive, clean house and equipment with lye water, a steam cleaner or high pressure sprayer. Allow to dry and disinfect interior of house thoroughly. Painting lower walls and roosts with carbolineum or creosote 3 weeks before chicks arrive will control mites in brooder house for the season. Fresh fumes from these may harm chicks.	Clean and disinfect whenever it becomes damp or odorless. Clean fountains daily with a stiff brush; disinfect weekly. Chicks may be allowed outside after two or three weeks, providing clean range is available. Move house frequently. If clean ground is not available, use concrete yards or wire sun-porches.	Avoid water puddles and trash piles. Move feeders and fountains frequently to avoid contamination of ground. Under no circumstances should chicks of any age be allowed to mingle with adult birds or run over yards that have been used recently by adult birds. Be on guard against coccidiosis. There are a number of sulfa drugs and other compounds available for control. Administer as directed.	Special range shelters are usually provided at this age. They should be cleaned and disinfected, with woodwork and roosts painted with carbolineum or creosote at least 3 weeks before the birds are placed in them. Birds should be moved to clean ground and sanitation practices previously mentioned followed closely. Provide shade.
Common Diseases	Omphalitis (mushy chick disease), pullorum, chick bronchitis, tracheitis, mycosis, and paratyphoid.	Pullorum, chick bronchitis, tracheitis, rickets and other vitamin deficiencies, perosis, mycosis, round and tapeworms, coccidiosis (sometimes pox)	Same as previously described in second column. Also typhoid, cholera, lice, mites, Blue comb, Newcastle, and leukosis (range paralysis).	
Miscellaneous Management	Assemble brooder and operate for two or three days before chicks arrive. Arrange feeders like spokes of wheel to allow easy access from heat to feed and water. Keep feeders full. Some cover litter with burlap sacks or paper for first 2 or 3 days to prevent eating of litter.	A night light (7½ watts or equivalent) will help to prevent piling at night. Remove brooder stove when no longer needed. Separate pullets and cockerels. Prevent cannibalism by allowing plenty of room, reducing temperature rapidly, providing plenty of feeder space, covering windows to admit only subdued light, and allowing chicks outside as soon as possible. If picking starts, check these practices again; also smear special, red, bitter tasting, anti-pick salve on picked chicks and others. Windows may be painted red. An additional one or two percent of salt in the ration, or one tablespoon per gallon of drinking water for a couple of days, also may stop it.		Treat for worms as necessary. If pox or laryngotracheitis is prevalent in your community, vaccinate as a routine practice any time after birds are 6 weeks old. Newcastle vaccination can be done any time after chicks are 3 weeks old, using live virus vaccine. They may be vaccinated earlier with killed virus or intranasal vaccine.



72 inch hover and an electric brooder with a 4 foot by 6 foot hover will each care for 300 to 500 chicks. Do not overcrowd the hover space.

**Use a Chick Guard**

A chick guard made of corrugated cardboard or other material should be placed in a circle around the hover about 3 to 4 feet out from the edge. A chick guard serves two purposes: It holds the chicks in near the heat, feed and water; and it helps eliminate floor drafts.

Move the chick guard back as the chicks grow and take it out when the chicks are big enough to jump over it.

Cardboard or other material may be used to round off the corners inside the brooder house. This will help eliminate the possibility of the chicks piling up in the corners from fright or cool temperatures.

**Feeder Space Requirements**

Provide at least one inch of feeder space for each chick the first four weeks. As the chicks grow, larger feeders and more feeder space will be required.

**Starting the Chicks**

Start chicks during day-light, preferably in the morning or early afternoon. This gives them a chance to find feed and water and get filled up before darkness.

The egg yolk is taken into the body just before the chicks hatch and is used as a "lunch basket" to tide the baby chick over until it gets started on feed and water.

In most cases day old chicks are ready for feed when they are picked up at the hatchery and should be placed in the brooder immediately. Chicks that are picked up in late afternoon probably should be held in the boxes overnight and started on feed and water early the next morning.

**First Feed**

Many hatcherymen recommend starting the baby chicks the first day on steel cut scratch grain or oat meal. They allow the chicks to fill up on this low protein feed before giving them chick starter. This has a tendency to eliminate bowel trouble or a black pasting condition that often occur when chick starter is used for their first feed. The feeders should be filled and additional feed spread on clean egg case flats or paper plates and placed under the hover before the chicks are put out. A chick naturally will pick at the handiest thing that looks like feed. By placing them on the feed they will start to eat immediately.

Change the egg flats or paper plates when they get dirty and discontinue their use entirely after 2 or 3 days.

After the chicks are two days old a handful of chick-size grit for each hundred chicks can be spread on the feed in the feeders every other day. When the chicks are 10 days old, hand-feeding grit should be discontinued. Grit can then be put in a low shallow pan.

**First Water**

The first 10 days or two weeks, baby chicks are not very big and do not require a great deal of water. But a

good supply of clean fresh water should be before them at all times. Two or 3 one-quart jars with fountain bases are sufficient for each hundred chicks. More jars can be used to require less frequent filling.

Use an easy-to-clean glass or porcelain base for the jars. Keep them clean and sanitary.

Start some of the chicks drinking when they are placed in the brooderhouse by dipping their beaks in the water. Some chicks drinking will attract others. After the first 10 days or two weeks the quart fountains can be replaced by one 3 or 5 gallon fountain per hundred chicks or automatic fountains.

Larger fountains or automatic fountains will reduce the labor required to keep an ample supply of fresh clean water in front of the birds at all times.

**Brooding the Chicks**

Crowding (due to overheating, chilling or frightening) can cause serious trouble. Some chicks can be injured to the extent that they will not grow and develop normally.

Manufacturers directions on the temperatures for various types of brooder stoves should be followed very closely.

Oil brooders have a thermometer at the edge of the hover about two inches above the litter. Electric hovers usually have a thermometer installed in the hover.

An experienced poultryman can brood chicks without the use of a thermometer. He will watch the chicks and can tell if the stove is too cold or too warm.

When chicks are comfortable at night they will form

**Recommended temperatures for oil brooders:**

	Hover temperature under edge of hover 2" from	
	floor	room temperature
1st week	95°F	70-75°F
2nd week	90°F	70-75°F
3rd week	85°F	70-75°F
4th week	80°F	70-75°F

Some stoves may require a higher or lower temperature; manufacturer's directions should be followed closely.

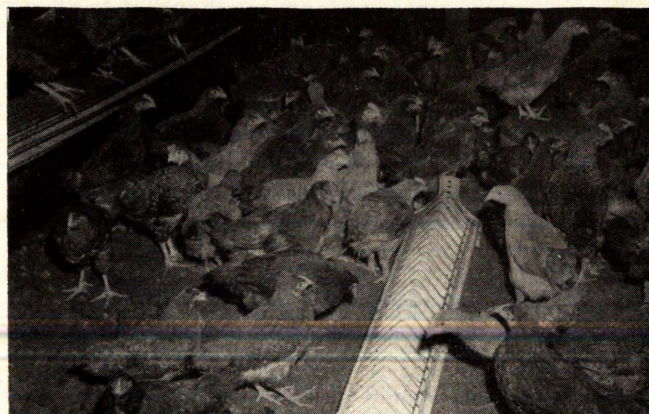

Fig. 4. Cockerels should be separated as soon as the sex can be determined and sold at 2½ to 3 pounds body weight.



an even ring a little way out from the hover of an oil brooder. They will distribute themselves evenly under an electric brooder.

Chicks crowd to the outside walls if the stove is too hot and crowd close to the stove when the room is cool.

The brooding temperature should be as cool as possible and still have the birds comfortable. The chicks will feather faster and eat and drink better.

#### Install roosts early

Low roosts may be provided for the chicks when they are three weeks of age. Chicks should be encouraged to use the roosts as soon as they are ready for them.

Allow about 6 inches of roost per chick for the first 6 weeks then increase the roosting space as needed to avoid crowding. (See Fig. 2, p. 3.)

#### Brooder House Sanitation

There is no wonder drug or medicine that will take the place of good brooder house sanitation. Once a brood of chicks get sick it will be harmed to a small or great extent, depending on the seriousness of the outbreak.

Water fountains should be thoroughly scrubbed with a stiff brush each day and disinfected weekly. Thoroughly clean and disinfect feeders before they are put into use.

Floor litter should be stirred with a fork or garden rake each day to keep it worked over and dry. The litter should be replaced if it gets wet and soggy. Wet litter encourages growth and spread of any disease organisms that may be present.

Provide screen plaforms for feeders and water fountains. This helps keep litter out of the feed and water. Where clean range or a sun porch is available the chicks may be turned outside after they are three to four weeks old when weather is good. This will help keep the litter dry.

Ventilation of the brooder house is one key to dry litter. Use as much air movement in the house as possible without cooling it down too much or causing drafts on the chicks.

Keep chicks away from water standing in pot holes on the ground. Dead animals and moldy grain are other things that can cause sickness in the flock.

#### Separate Pullets and Cockerels Early

When straight run chicks are purchased the pullets will grow and develop better if separated from the cockerels at about 6 to 8 weeks.

Weather permitting, the pullets can then be moved to range shelters out on good clean range where they can be reared until they are about to come into production.

The cockerels can be held in the brooder house and marketed at 9 to 11 weeks as broilers when they weigh around 3 pounds. Leghorn or Leghorn crosses should go to market a little earlier than heavies. They tend to lose some tenderness after they weigh 2 to 2½ pounds.

In some cases it may be profitable to carry the cockerels to a heavier weight and caponize them. Chemical capons (di-ethylstilbestrol) should probably go to market at 6 to 8 pounds. Surgical capons may be carried until they weigh 8 to 10 pounds.

Before the birds get past the 2½ to 3 pound stage it is advisable to check with the producers in your area and see if there is a market for caponized birds. With good management and feeding, a bird can be grown to 2½ to 3 pounds on about three pounds of feed per pound of body weight. As the bird grows older it will take more pounds of feed to produce a pound of body weight.

#### Management Feeding on the Range

A good range, properly used, can save as much as 10 to 20 percent of the feed bill for a flock of pullets. The birds will be healthier if allowed to run on clean ground and away from other birds on the farm.

#### Choosing a Range

A good range is one that provides an abundant supply of succulent green feed for the birds over a long period.

Brome grass, alfalfa, or brome and alfalfa mixed make a good pasture for poultry. Oats, wheat or rye crops also can be used to good advantage. Small grains can be

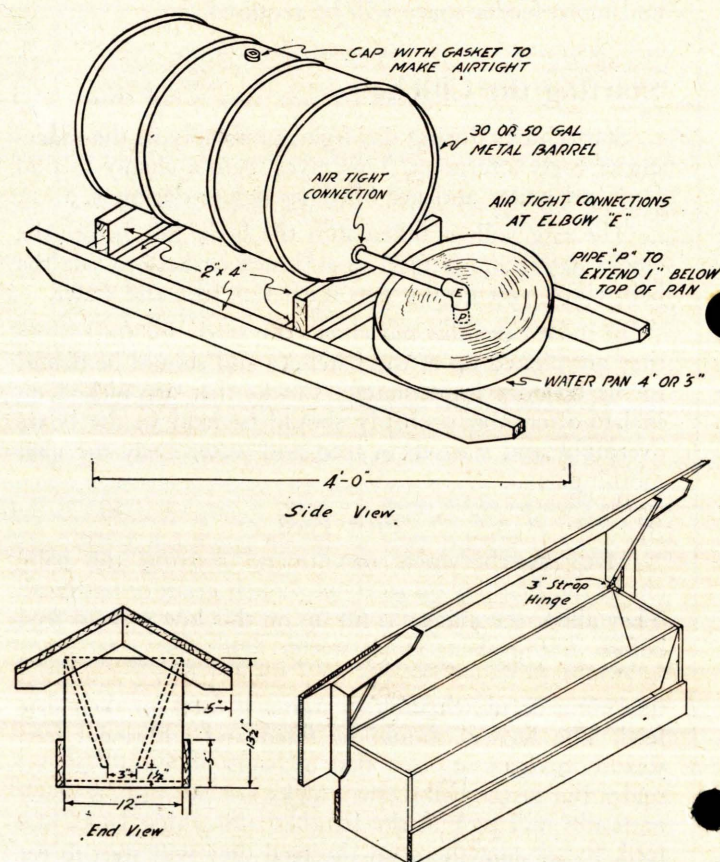

Fig. 5 (top). On the range an old oil drum makes a satisfactory waterer. It can be made up as pictured or fitted with a hose and automatic water fountain. This unit should be placed in the shade so the water will stay cool.

Fig. 6 (bottom). This outdoor range feeder is to be used when young chickens need larger feed hoppers—when the chickens weigh two or three pounds. This feeder is 5 feet long, 1 foot wide and 13½ inches high. The top boards extend over five inches to keep out rain and provide shade. This hopper is sufficiently large to reduce labor in refilling. Larger feeders as this one are higher from the floor or ground and prevent litter from being scratched into them.



planted at different intervals during the summer to supply a constant supply of succulent green feed. Clip brome or alfalfa, when it becomes tall and woody, so a new growth will start.

When the grasses become hard and woody they are not palatable to the birds and they will not eat the forage. Locate the range near a corn field so the birds can get additional shade during the hot part of the day.

The range land should have a gentle slope so that it will not contain puddles of stagnant water after rains.

The range should be located on land where no chickens have been allowed to run for at least one year; two years is better. Chicken manure should not be spread on the land to be used for poultry range during the next year or two.

### Range Equipment

Range equipment consists of a shelter to protect the birds from the weather and predatory animals; feeders that will protect the feed from the wind and rain; and water fountains that will provide an ample supply of clean water at all times.

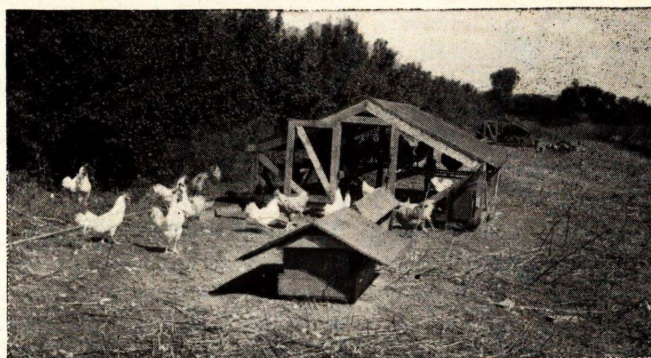

Fig. 7. This is one type of range shelter commonly used. A 10 x 12 shelter will care for 125 to 150 pullets. Note the range feeders that protect the feed from wind and rain.

### Range Shelters

A common type of shelter is pictured in Fig. 7. This shelter provides a roof, wire sides and floor roosts for the birds. It is light and easy to move.

If the weather is cool when the birds go on range the

Table II. Examples of Poultry Feed Formulas  
Chicken

Ingredients	Starter (0-8 weeks) Per Ton	Broiler Mash <sup>1</sup>	Grower <sup>2,3</sup> (8-7 weeks)	Laying Mash <sup>2</sup>	Laying Concentrate <sup>4</sup>	Breeder Mash <sup>5</sup>
Ground yellow corn	Lbs. 800	1140	500	520	200	680
Pulverized oats <sup>5</sup>	Lbs. 300	-----	300	200	120	200
Wheat flour midds	Lbs. 100	-----	-----	-----	-----	-----
Wheat Standard midds	Lbs. 100	-----	300	400	300	200
Wheat bran	Lbs. -----	-----	200	200	300	200
Meat scraps	Lbs. 100	-----	100	100	300	200
Fish meal	Lbs. 50	40	-----	-----	-----	80
Soybean meal (44%)	Lbs. 380	630	300	400	540	200
Dried buttermilk	Lbs. 50	20	-----	-----	-----	80
Dried Brewers Yeast	Lbs. -----	-----	-----	-----	-----	-----
Alfalfa meal	Lbs. 60	40	200	100	120	80
Steamed bonemeal	Lbs. 20	80	40	40	60	40
Ground Limestone	Lbs. 20	10	-----	-----	-----	-----
Salt mix <sup>3</sup>	Lbs. 10	10	20	20	30	20
Animal fats	Lbs. -----	40	-----	-----	-----	-----
Dry Vitamin A and D Mixture	*	-----	-----	*	*	*
Methionine <sup>7</sup>	Lbs. 1	-----	-----	-----	-----	-----
Calcium Pantothenate	gms. -----	6	-----	-----	-----	-----
Niacin	gms. -----	10	-----	-----	-----	-----
Riboflavin	gms. 1	3	-----	0.5	1.0	2
Vitamin B <sub>12</sub>	mg. 1	5	3	3	5	5
Antibiotics <sup>8</sup>	gms. 2-10-100	2-10-100	2-10-100	0(4-20-200)	0(6-30-300)	0(4-20-200)
Arsenicals <sup>9</sup>	gms. 45-120	45-120	45-120	0(90-240)	0(135-360)	0(4-20-200)
Calculated protein	% 20	20	20	20	26	20

### Footnotes

1. Provided all ingredients are of excellent quality, this diet will give satisfactory results. Both the starter and broiler mashes should be fed as all-mash diets for six weeks; then grain feeding may begin on a limited scale.

2. To be fed with equal parts of grain, supplemented with oyster shell and granite grit.

3. These diets are intended for use with limited green range. If luxuriant green forage is available, the alfalfa meal may be replaced by wheat by-products or ground cereal grains.

4. To be fed free choice with grain, supplemented with oyster shell and granite grit.

5. Various other cereals could replace oats, such as wheat, milo, millet, barley or corn.

6. A mixture of 39 pounds of iodized salt and one pound of manganese sulfate.

7. From one to two pounds of methionine may be added for improved feed efficiency and feathering; also one to two

pounds of betaine or choline chloride should be added to turkey starters.

8. Various antibiotics, such as penicillin (to which the lower level applies) aureomycin, bacitracin, and terramycin intermediate level for the latter three can be used in starter and grower rations for improved growth and feed efficiency. Work at this station indicates that the antibiotics may be added to laying and breeding rations to effect from zero to eight percent improvement in egg production, hatchability, and feed efficiency. Antibiotic and vitamin B<sub>12</sub> potencies are indicated by the manufacturer and should be used accordingly. Recent evidence indicates that under certain conditions of endemic infections, higher levels of antibiotics may be used economically.

9. The organic arsenicals (3 nitro 4 hydroxy phenylarsonic acid, lower level, and arsanilic acid, higher level).

\*Vitamin mixture should provide 300 International Chick Units (I.C.U.) of vitamin D and 2000 International Units (I.U.) vitamin A per pound of feed.



## Your Layer-Management Guide

Table III reproduced through courtesy of Poultry Tribune

Season	Before Housing	Fall Management	Winter Management	Spring & Summer Management
Housing	Many types of laying houses are available. Commercial producers sometimes prefer two or more story houses. Wide houses are preferred because they provide more comfortable conditions for the flock. Twenty feet is considered to be as narrow as any laying house should be built. Large capacity buildings may be 30 to 40 ft. wide. Providing three square feet of floor space for light breeds and four for heavies is a standard recommendation. One square foot of window space should be provided for each 20 to 35 sq. ft. of floor space.		Don't overcrowd. An insulated house is preferred for good winter production. Insulating board, fill type insulating material, bat and reflective types are all good when used properly. Good insulation reduces temperature fluctuations within the house, making it warmer in winter and cooler in the summer.	Painting the roof with reflective paint will help keep the house cooler. Large houses are more comfortable. Windows should be arranged to provide for cross ventilation during the hot summer days. All windows should be screened with heavy gauge poultry netting or wire fabric to prevent the entrance of wild birds.
Feeding Equipment	Use low feeders with perches. Feeders should be high enough to keep litter from being scratched into them. Grill or reels are necessary to keep birds out of feed. With most systems of feeding, one foot of feeder space is necessary for each three hens. Use heavy, substantial feeders. Provide hoppers for grit and calcium supplying products.		Keep equipment in repair. Don't overfill feeders. Placing feeders at right angles to light is recommended for small, poorly lighted houses. Placing them parallel with the length of the house is recommended for large, modern houses as it saves steps in filling. Have a central feed house or feed bin. It will help save time.	
Watering Equipment	Running water under pressure is a necessity for flocks of any size. Trough or fountain types, cup types and drip systems are all satisfactory when properly installed. Select a rigidly built fountain and install as recommended by manufacturer. Don't stint on water space. If water under pressure is not available, use one 8-gal. fountain for each 100 hens. If trough or fountain type equipment is used, plan to drain and brush it out each day. Keep all equipment clean and sanitary.		Use frost-proof, underground shut-off valves or electric soil heating cable to keep exposed supply lines from freezing. Keep water in open fountains warmed to 50 degrees F. There are many electric and kerosene lamp heating units available.	Each 100 hens will consume or waste 6 gallons of water a day. Keep water fresh and clean and always available. Lack of water in summer will cut production quickly. Unsanitary watering equipment is a disease hazard.
Dropping Pits and Roosts	Use properly built dropping pits and roosts. Pits should be 14" to 18" high. Roosts should be 12" to 14" apart, and 7" of roost space should be provided for Leghorns, 10" for heavies. 1" x 4" mesh 12 1/2 gauge welded wire fabric should be placed under the perches to keep birds out of pits. Other types of wire netting may be used but are not as satisfactory. Paint all pits and roosting equipment with creosote or carbolineum three weeks before housing. Be sure all pullets get on roosts the first week they are in the laying house.		If pits are deep enough and substantially built, they should need little attention other than to clean them two or three times a year. The use of lime or superphosphate over the droppings will help retain the fertilizer value of the droppings. If pits and roosts were not painted with carbolineum or creosote in the fall, watch for mites. They hide in cracks on perches. Spray with cresol solution if they are found. Occasionally spraying with DDT around roosting quarters will control flies during the summer months.	
Ventilation	Windows, slots, ventilation flues, and forced draft fan systems Use a system that has been found to be satisfactory in your area. If electric exhaust fans are used, the fan capacity usually recommended is two cubic feet of air per minute for each light breed hen and two and two-thirds for each heavy breed hen housed.		Protect birds from direct drafts. Close windows up as weather becomes more disagreeable. Check ventilating equipment to see that it is working properly. Don't close house up too tight.	Open windows and ventilators as weather becomes warmer. Provide plenty of cross ventilation during hot weather.
Litter	Deep litter is recommended. Start it early, during warm weather if possible. Use commercial litters, such as shredded cane fiber, treated cottonseed hulls, mineral litters, or peat moss. Other materials that can be used are chopped straw, wood shavings, or ground corn cobs. Avoid moldy litter. In starting, put in a light layer of litter over one-half inch of sand. Clean laying houses thoroughly before starting deep litter. From time to time, add new litter, until a layer five to eight inches thick is built up.		Add lime at rate of 1 lb. to 2 to 3 sq. ft. of floor space in case of dampness. To start deep litter during cold weather, put in thin layer of new litter and add old litter from pens where deep litter is already in use. Stir litter to keep from caking. Remove wet litter around fountains.	Keep litter evened up over floor of house. Don't let caked spots develop. Properly cared for deep litter may be used two or more years where diseases are not a problem.
Selection and Culling	Follow a good pullet rearing program. Pullets are no better than their breeding, plus the management and feeding provided by the flock owner.	House pullets as they mature. Put pullets of about the same maturity in each pen. Select strong, well-developed and pigmented pullets. Remove all those showing indications of leukosis or other diseases.	Cull out pullets that go bad, show signs of disease or indications of being poor producers. Large red combs and well-bleached legs and beaks in yellow-skinned breeds are signs of good producers.	Continue to cull as indicated for winter management, but now take molt into consideration. Early molters are poor layers. Watch for them and sell them as they develop. A few such birds will begin to develop in June.
Lights	Install a reliable time switch for controlling lights. It can be a switch for turning the lights on in the morning and off in the evening, or a morning switch only. If a uniform length day is wanted, the morning and evening switch should be used with a dimming device. Use one 40-watt bulb for each 200 sq. ft. of floor space, the bulbs being placed not more than 10 ft. apart. Lights are usually started in September or October, depending on date of hatch of pullets. The earlier hatched pullets should have lights first. Provides 13 to 14 hours of light a day.		Dust bulbs and reflectors occasionally. Irregularity in use of lights may cause molting. Replace damaged or burned out bulbs.	Discontinue lights in March or April. Discontinue gradually. Morning lights are sometimes used on old hens starting in August to encourage early eating and stimulate production. They are especially useful during hot weather.
Feeding	Most feeding programs are built around the mash used. All-mash, mash and grain hand fed, and free choice grain and mash are the three basic methods. Some producers favor one system, some another. Whatever system is decided upon should be followed carefully.	Use the range feed and feeding program for a few days after housing. Switch gradually to laying house program. Use a high quality ration and feed it as directed by the manufacturer. A source of grit and calcium should be provided in addition to regular ration. Some producers favor supplementary booster feeds to hold up production. Milk products, pellets, and wet mashes, are used according to manufacturers' recommendations. If wet mashes or pellets are used, don't overfeed. Provide only the amount that will be cleaned up in 20 to 30 minutes.		Booster feeds are often continued throughout the spring and summer. Stirring mash in feeders occasionally invites birds to eat. Don't put too much feed in feeders. Avoid waste at all times. Feed from day to day. Birds relish fresh feed at all times.
Sanitation	Birds should be vaccinated before housing for chicken pox and laryngotracheitis if those diseases are present in the area in which the flock is located. Vaccinate for Newcastle if present in your area, depending on how the disease is being handled in your state. Handle birds in clean coops and keep visitors out of the house. Screen houses against sparrows and other birds. Be sure all birds are free of lice when housed. House pullets in properly cleaned houses. Use a steam cleaner or hot lye water for cleaning.		Remove diseased birds as soon as noticed. Clean water fountains daily. Keep feeders clean. Watch birds for signs of lice infestation. Confined birds are less likely to pick up diseases. Don't introduce new birds until they have been treated for lice and isolated three weeks for observation. Be sure they have been properly vaccinated also. Bury or burn all dead stock, or dig a disposal pit to make disposal of dead stock easier. Plan to get on an all-pullet flock program if you are not on one at present.	
Common Diseases and Parasites	After housing, pullets should be watched carefully. Diseases that are apt to appear are Blue Comb and various respiratory diseases. Give an individual worm treatment at housing time if necessary. Treat for lice if necessary.		There are many diseases that may develop in the laying house. Leukosis infected birds may develop more pronounced symptoms. Cholera, typhoid, colds, Newcastle, pox, or laryngotracheitis may appear. Rely on your veterinarian and your state diagnostic laboratory.	
Egg Handling Program	In the laying house provide one nest for each 5 hens or one community nest 2'x8' in size for each 50 hens. Gather eggs in wire baskets.	Keep floor eggs gathered after housing to encourage laying in nests. Keep nests well padded with good nesting material.	Gather eggs three times a day. Follow deep litter program to insure drier litter and cleaner eggs. Take eggs from laying house to a cool, moist egg room for holding and packing. Pack all eggs small end down in clean fillers and flats. Market often, at least twice a week.	
General Management	Plan to use anti-picks, or debeak. Either will control cannibalism. Make arrangements to handle pullets with the least confusion.	Keeping complete records makes it possible to compare each year's operations and discover the weak points in management.	Be regular in feeding and chores. Study chore route and efficiency of routine in getting flock work done. Don't waste feed.	Keep flock confined. If males are kept, sell them after breeding season is over. Keep equipment in good repair.



back and sides can be covered with burlap or wall board to break the wind.

The door to the shelter should be closed at night to keep predatory animals away from the birds.

### Range Feeders

A good range feeder holds a large supply of feed, is easy to move, and will protect the feed from wind and rain. See Fig. 6.

Provide one 5-foot feeder for growing mash and one 5-foot feeder of grain for each 100 birds on the range.

### Water on the Range

It is necessary to keep a supply of cool, clean water before the birds on the range at all times. Automatic fountains attached to barrels or running water piped to the range are great labor savers.

Figure 5 shows a practical type of water apparatus that can be placed on a stand so it can be moved with the shelter.

The water should be shaded from the direct rays of the sun in order to keep it cool.

One automatic water fountain should be sufficient for each range shelter unit.

### Harden Birds Before Moving to Range

The windows should be taken out of the brooder house a few days before the birds are to be moved to the range to give them a chance to harden-off and get accustomed to cooler temperatures that they will be subjected to in the range shelter.

### Feeding on the Range

A balanced ration on the range includes growing mash, grain, green feed and water. Grass and grain are not enough to develop the pullets into strong, healthy layers. Holding back on the protein feed will retard the growth of the pullets and it will take them longer to develop and come into production. Mash should be supplied at all times and can be fed at all different levels of protein from 16% to 26%. Total feed should contain about 15% to 16% protein and the amount of grain fed with the mash will vary with the protein level in the mash. Follow the feed companies' recommendations with the particular type of feed used.

A grain mixture of  $\frac{1}{3}$  oats and  $\frac{2}{3}$  corn can be fed in one 5 foot self-feeder for each 100 pullets. Additional grain may be spread on the range each day to encourage the birds to move away from the shelters and get more exercise. The grass or green feed should be clipped often so new shoots are growing at all times. If the grass is allowed to become long and woody the birds will quit eating it.

Care should be exercised in clipping the range. It should not be clipped too short. If clipped during dry weather the grass may not start to grow again until it gets moisture; or it may be killed out entirely.

### Range Sanitation

Sanitation on the range is an important part of range management. The range shelter should be moved to a new spot each week or so, or when the range starts to get worn out around the shelter.

Shelters should not be moved more than one or two hundred feet at a time. The birds will lose the shelter and want to roost on the same spot if the shelter is moved too

far at once. Each time a shelter is moved, the droppings that have accumulated under it should be picked up and hauled away so the birds can not scratch in them.

Continually moving the birds to clean ground will help to keep the birds healthy. Contaminated ground will harbor coccidiosis, black head, worm eggs, cholera and other disease organisms.

Water fountains are easily contaminated by the birds and must be kept clean. Use the same precautions here as you would in the brooder house. Brush them out daily and disinfect them once a week.

Water fountains should be placed on a wire platform or moved often to eliminate the birds' drinking from puddles that may form.

### Vaccination on the Range

Where fowl pox and Laryngo Tracheitis are a problem on the farm, vaccination against them should be done on the range when the pullets are 12 to 16 weeks of age.

Vaccinate birds only when they are in good condition and when the weather is dry and warm. Contact your local veterinarian to have the work done or he may sell you the supplies and you can do the work yourself.

General vaccination for newcastle disease is not recommended at this time in South Dakota.

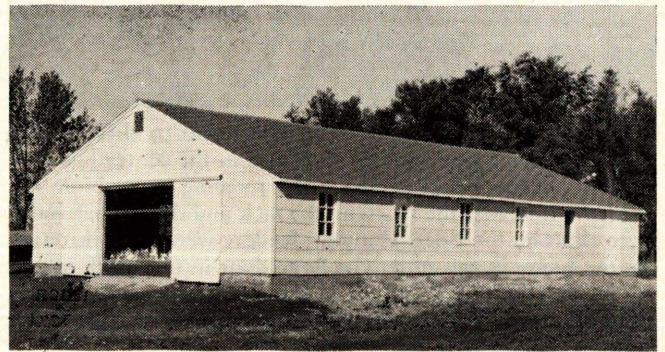

Fig. 8. This is one of the modern insulated and ventilated poultry houses built from S. D. Extension Circular No. 515. The house is 30 x 50 feet and will accommodate 500 to 600 laying hens.

### Confinement Rearing

Some prefer raising pullets in confinement rather than on the range. Advantages: This system conserves labor and provides the advantages of using the electricity and automatic water supplies found near the farm buildings. There is also less danger from predatory animals when pullets are confined.

Disadvantages: Possible higher expense for housing, a sun porch is required and there is generally a 10% to 20% higher feed cost.

Pullets reared in confinement are equally as good as pullets reared on the range.

In some cases old poultry houses are kept on the farm for confinement rearing where new and larger modern houses are constructed. These quarters can also be used to hold old hens a few weeks after the pullets are housed.

At least one to one and one-half square feet of floor space in the house and an equal amount of space on a sun porch should be provided each bird in confinement rearing. (See Fig. 3, p. 3.)



## Laying House Management

Egg production accounts for a high percentage of the poultry income in South Dakota. A profitable flock is one that will maintain 60% to 70% production throughout the laying year.

Chickens are very temperamental. When they are in good production they will respond quickly to poor management. They can be thrown into a molt and out of pro-

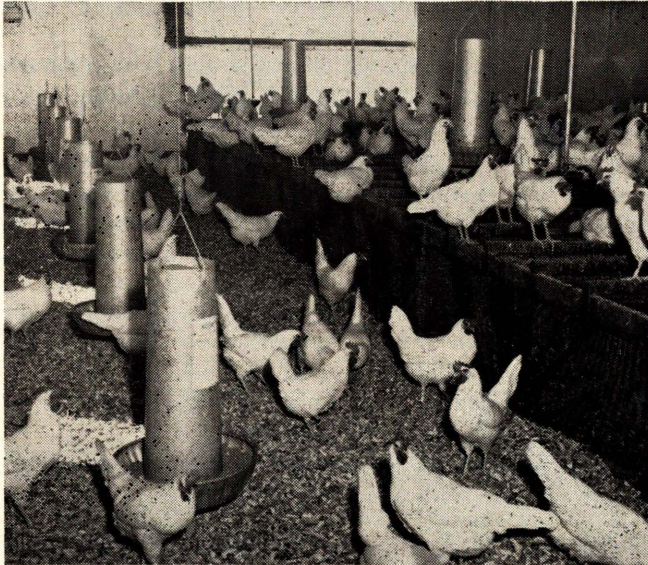

Fig. 9. Note the arrangement of equipment in this modern poultry house. The dropping pit island in the center has both feed and water installed above the roosting area. Note the welded wire under the roosts on the rack and the 1/4-inch hardware cloth on the sides. Hanging feeders were used throughout the house in this unit. The large door in the south end of the house admits sun and air in the summer and is a handy clean-out door. Small tractors and equipment can enter through this door.

duction for several weeks if routine management is changed quickly or when some part of the daily routine is left out entirely for a couple of days.

### Preparation of the Laying House

A warm poultry house is a necessity in South Dakota where we have long, severe cold spells in the winter.

All old hens should be sold or moved to temporary quarters two weeks to a month before the new flocks are to be housed.

The house should be cleaned and disinfected the same as the brooder house. Set all equipment (such as feeders, fountains, nests and dropping pit sections if they can be removed) outside. Sweep down the walls and ceiling with a broom. Clean the floor and lower wall surfaces until they are free of droppings. Wash down with boiling lye water and spray thoroughly with a good commercial disinfectant.

Scrape all equipment, scrub with boiling lye water and spray with disinfectant. Allow the equipment to stay in the sun and dry.

Spray the roosting and nesting areas of the house, dropping pit sections and nests, if wooden nests are used, with carbolineum or wood preserver. One thorough treatment should control mites for a year. Caution should be

used when working with carbolineum so that it doesn't get on the skin as it will burn and blister where it touches. Carbolineum also will burn the skin of the birds if they come in contact with it before it is thoroughly dry.

Houses with dirt floors are a little harder to clean than those with cement or wood floors. A dirt floor can be soaked with disinfectant after it is cleaned or sprinkled with a layer of dry dip. If the old hen flock had a serious outbreak of disease the year before, it would probably be advisable to skim off four or five inches of soil and replace it with gravel or clean soil.

### Repair and Remodel the House

Necessary repairs and remodeling should be done while the house is empty and before the birds are housed. Leaky roofs give rise to wet litter, and should be repaired. Broken window lights should be replaced. Broken or sagging doors should be repaired.

### Insulation of the House

Insulation will pay for itself over a period of years in more eggs for less feed. It will make the house more comfortable for the birds in both extremely hot and cold weather. Insulation is the key to proper ventilation and the use of deep litter.

An insulation job need not be expensive. A vapor proof material, such as sisal kraft, asphalt impregnated paper, polyethylene or aluminum foil should be placed on the inside of the studding, then sheath up the inside of the wall with the cheapest lumber available. Fill the space between the studdings with ground dry corn cobs (ground pea size), wood shavings, or sawdust if they are available. Mix about 1 pound of hydrated lime with each 10 pounds of fill to discourage rats and mice should they get in. Tamp the fill in as you work your way to the top of the wall.

Two or three coats of aluminum paint on the wood surface will add to the appearance of the house and preserve the boards.

The type of ventilation used will somewhat govern what is done with the ceiling. Slot ventilators and fan ventilation require a solid ceiling. This can be insulated much the same as the wall. Put a waterproof paper on the underside of the joists and sheath with cheap lumber. Cover the attic floor with 8 to 10 inches of ground cobs, shavings or sawdust and lime, four inches of commercial insulating is sufficient. Heat has a tendency to rise, so adequate fill is needed above the ceiling, a four inch fill or double thick blanket is sufficient on the wall surfaces.

Louvers should be put in the gables of the house to allow circulation through the attic to carry away any moisture that might accumulate due to a leaky roof or moisture escaping through the ceiling.

A door into the attic is handy for installing the insulation. The attic area also may be used for storing brooder equipment or other things.

An insulation job is not complete unless some form of

Fig. 10. Plan of arrangement in the South Dakota 500-size poultry house. Note the floor plan showing nesting room, feed bins, vestibule, dropping pit area, feeders and water fountains. It shows fan locations and slot ventilator inlets through the ceiling. It also includes a wiring diagram.



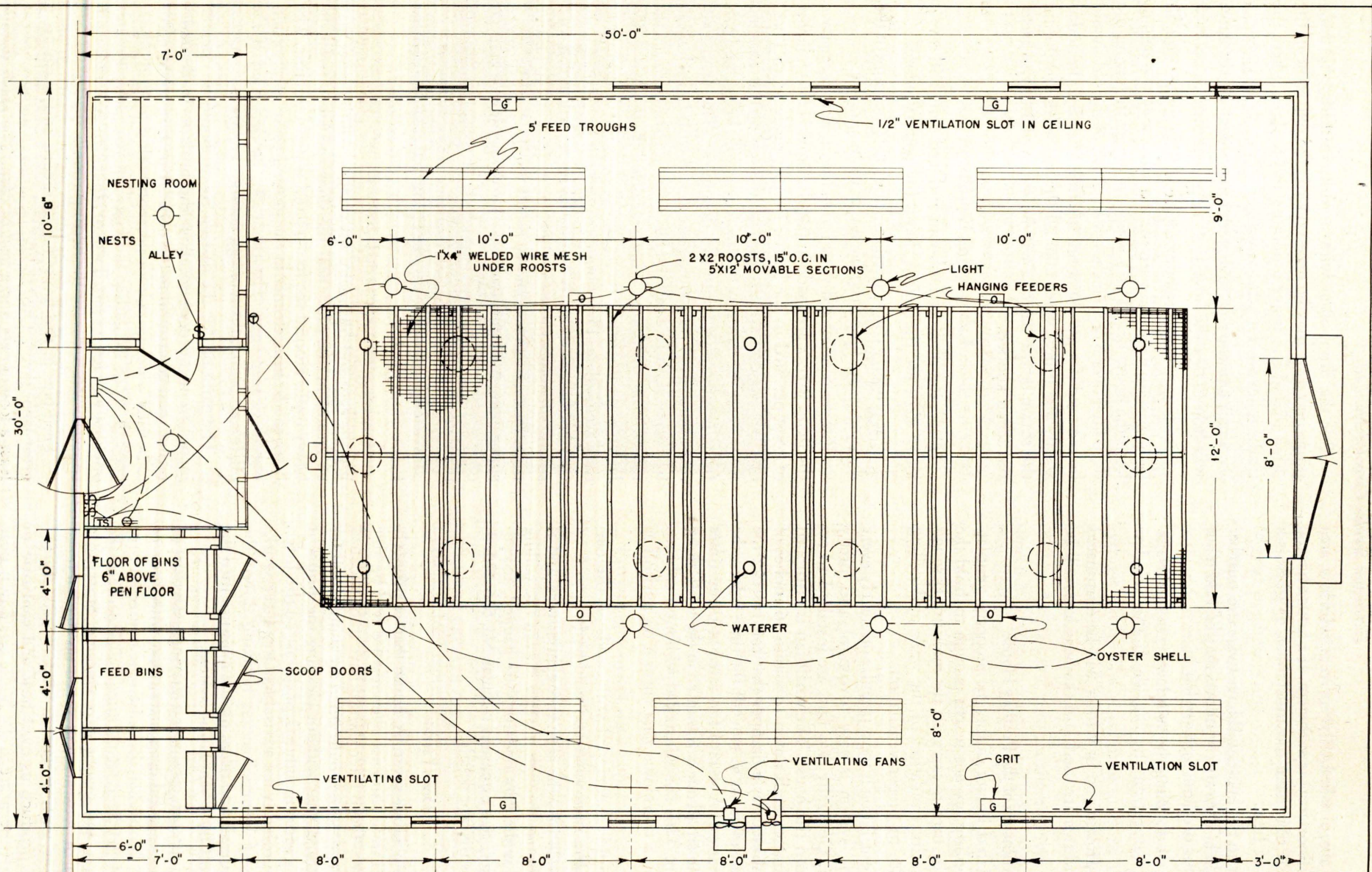

NOTE.- ORIENT BUILDING SO THAT IT  
RUNS NORTH AND SOUTH.

FLOOR PLAN  
SCALE 3/8"=1'

500 HEN LAYING HOUSE

EXTENSION SERVICE

SOUTH DAKOTA STATE COLLEGE  
U.S. DEPARTMENT OF AGRICULTURE

CO-OPERATING

DESIGNED BY *W. H. ...*

SHEET 1 OF 6

DRAWN BY *W. H. ...*

NO. 314

CHECKED BY *H. H. ...*

DATE JUNE 1954

APPROVED BY *George F. ...*

SCALE AS SHOWN

DIRECTOR OF EXTENSION



storm windows are installed. Five percent window area (compared with floor area) is sufficient. If a house has too many windows, it may lose too much heat, as glass is a good conductor of heat.

In some cases an old house will have twice the number of windows needed. The extra windows may be taken out and used as storms on those that are left in.

Another way of doubling the windows is to nail transparent glass substitutes on the outside of the window casings.

Much of the frosting-up in winter will be eliminated when storm windows are used and the heat loss will be reduced greatly.

### Ventilation of the Poultry House

Most uninsulated houses cannot be properly ventilated. Walls and ceiling are not warm enough to hold the heat in so it can be used to carry off the moisture through a ventilating system. Insulation of the walls and ceiling are a pre-requisite to proper ventilation.

Electric fan ventilation is most popular on nearly every farm. An electric system is easy to control and pretty much fool proof. Generally two fans are installed to exhaust foul air from the house. The small fan is equipped with a cabinet that extends down to within 16 inches of the floor. The cabinet has a damper that can restrict the flow of air. This fan is set to run all the time when the system is in operation. A second fan rated at three times the capacity of the small one is mounted in the wall along side the small fan. This fan is installed without a cabinet. It is controlled by a thermostat that turns it on and off as needed.

Both fans should be equipped with hoods on the outside to keep out the rain, wind and wild birds.

Fresh air travels into the attic through louvers and is admitted to the house through narrow slots in the ceiling near the outside walls. Slot openings are gauged according to fan capacity. See extension circular No. 516 "Modern Poultry Housing" for details.

### Deep Litter

Deep litter is a labor saver. A house that is properly insulated and ventilated and not overcrowded will be able to use a deep litter. Deep litter should have to be cleaned out only once a year. Some poultrymen are using the litter the second and third year without cleaning the house if they haven't had a serious outbreak of disease on the litter. However, this is probably not advisable. Deep litter works on the principle of bacterial action breaking down the droppings into humus and releasing the moisture into the air to be carried off by a ventilating system.

Coarsely ground corn cobs, wood shavings, sawdust or chopped straw make good deep litter. Start with four or five inches on the floor when the pullets are housed. Three or four inches of dry feed-lot manure will inoculate the litter with bacteria and help it start working. Starting a deep litter in warm weather will speed up the bacterial growth while it is getting started. Once it gets started working, it will produce its own heat and continue to work unless the temperature in the house gets down near freezing.

Stir the litter often with a fork, working the droppings into it. It may be necessary to take out some of the litter around the water fountains and feeders, where the traffic is heavy, if it gets too wet.

Small amounts of hydrated lime mixed in the litter will help to dry the litter if it has a tendency to get wet.

Adding a small amount of fresh litter from time to time, stirring it in well with the old litter, will also help to keep the house dry. There is no advantage in having the deep litter over 8 or 10 inches deep. Some of the old should be removed if a great amount of fresh litter is to be added at any one time. Never take all the old litter out during the season or the bacteria will be removed and the bacterial action stopped.

### Labor Saving Equipment

Dropping pits, nesting room and feed pens will save a lot of steps for the person doing the poultry chores.

Pits properly constructed can catch 65% or more of the droppings and help keep the house clean and dry.

Pits are constructed with roosts about 30 inches above the floor. Roosts are made in panels. Provide 6 to 8 inches of roost per bird in the house. Frames made from 1"x4" or 2"x4" welded wire stapled to the top of the roosting frame and the bottom of the roosts will keep the birds from getting down into the droppings. The front and open sides of the pit should be screened with 1/4 inch mesh hardware cloth to keep the birds from getting under the roosts in the droppings. Hardware cloth will allow circulation of air under the roosts and dry out the droppings as they accumulate. Dropping pits need not be cleaned until they are full. A properly ventilated house will not have a smelly dropping pit. Sometimes an objectionable ammonia odor can be overcome by sprinkling hydrated lime or super phosphate fertilizer on the droppings in the pit once a week. Super phosphate will increase the value of the droppings as fertilizer.

Bacterial action in the dropping pit creates heat that helps warm the house in extremely cold weather.

A nesting room is a labor saver for the person gathering the eggs and has many advantages. All the nests may be located in one place near the door and away from the heavy traffic around the feeders and water fountains. The litter can be kept cleaner in the nesting room area, resulting in cleaner eggs. The room can be darkened if the birds start cannibalism or egg eating.

The partition for the nesting room should be open 20 inches from the floor to allow the birds to walk under rather than go around to the door. A nesting room needs to be only wide enough for nests on both sides and allows enough room to gather the eggs conveniently. Provide one nest for each 5 hens. Two- or three-tier shelf nests will conserve wall space in the nesting room.

Feed bins in the house for oats, corn and mash are a great labor saver. They should be large enough to hold at least a load of oats and a load of corn. The mash storage space can be smaller. (See Fig. 10).



## Housing Pullets

The pullets should be watched very closely when they are ready to start egg production. The comb will redden and their bodies will grow wide and deep. They should be put in the laying house just as they are coming into production or by the time 5% to 10% of them have begun to lay.

Moving a flock after they are in heavy production will often throw them into a partial molt. A molting bird will hold back on egg production while it is growing feathers.

### Feeding for Production

Percentage-of-production is the number of eggs gathered each day from each hundred pullets that are being fed in the house. It is the governing factor that determines profit and loss with the poultry project. Sixty to 70% production throughout the laying year is considered good production in a flock. The higher the percentage-of-production the lower the feed cost per dozen eggs produced.

It is necessary to feed a balanced ration in order to get high production over a long period of time. A balanced ration consists of mash or concentrate and grain in relative amounts to give the pullets a 15% to 18% protein intake on total feed consumed.

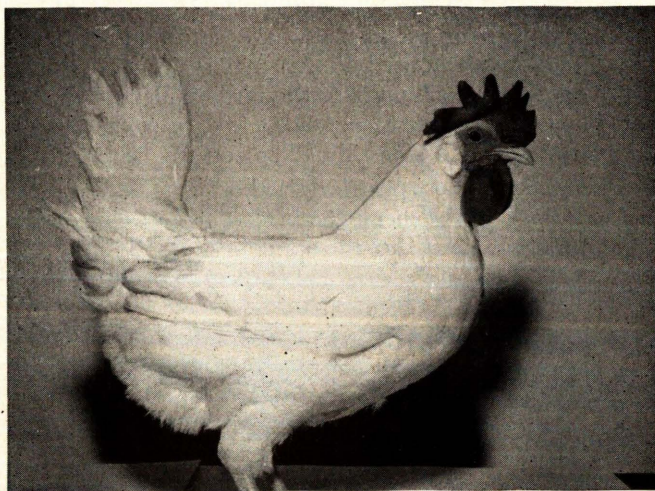

**Fig. 11.** A good layer has a large, red, waxy and full comb, her beak is bleaching or bleached. Her eye is bright and prominent and she has a neat and refined head, she is alert and friendly. Her body is wide and deep with worn and ragged feathers.

A constant supply of oyster shell is required for laying birds. Grit is necessary for full utilization of the feed and an abundant supply of fresh clean water before the birds at all times is a must.

Laying mash can be fed in several different ways depending on the protein level. Sixteen per cent laying mash should be fed as an all-mash ration. A 20% laying mash should be fed 50-50 with grain. A good practice is to put mash in all the feeders and have it before the birds all the time. Give them about  $\frac{1}{3}$  of their grain by weight in oats in the morning and  $\frac{2}{3}$  of the grain by weight in corn in the evening before they go to roost. A flock in heavy production will eat around 30 pounds of feed a day per hundred birds. This would be 15 pounds of a 20% mash, 5 pounds of oats and 10 pounds of corn. Some flocks will

have a tendency to get fat on this much corn and if this happens the morning feeding of oats can be increased and the evening feeding of corn decreased. Still keep the 50-50 ratio of mash to grain.

The 25% protein mashes can be fed on a free choice basis. Fill half the feeder space with mash and half with oats and corn. The mash-grain ratio on this system of feeding should be  $\frac{1}{3}$  mash and  $\frac{2}{3}$  grain.

Free choice feeding is probably most practical for the average farm. The maximum amount of home grown grains are utilized with this method. Follow feed company recommendations.

The 32% to 35% protein concentrates can be used but should be diluted with ground grains to bring the protein level down to 25% or lower. Usually a flock will eat more of the concentrate than is needed if it is fed on a free choice basis. It probably won't hurt the bird but will increase the cost of feeding the flock, thus lowering the profit. (See SDSC Poultry Mashes, on page 7.)

Provide at least two eight-foot feeders per hundred pullets on any of the feeding programs. Three feeders are better or at least 4 or 5 hanging feeders per 100 birds. It is false economy to give the birds less feeder space than they need.

When feeder space is short the timid birds will be crowded away and are not able to maintain the proper feed intake to produce efficiently. They often resort to filling up on what they can find in the litter while they are waiting for the stronger birds to move away from the feeders.

Provide one oyster shell hopper for each 75 to 100 pullets. Placing some of the hoppers on the back wall above the dropping pits will increase shell consumption. Birds need a good supply of oyster shell in order to put a good sound shell on the eggs.

Hen size granite grit or coarse bank run gravel should be provided at all times. Grit has no feed value but acts as a grinding agent in the gizzard and the birds are able to utilize the feed more efficiently.

At least 8 gallons of clean fresh water should be supplied to each hundred pullets daily. An egg is 66% water. Water is also an important part of the hens body and is necessary for proper health and digestion.

Automatic fountains connected to a barrel or pressure line are labor savers. One fountain should be provided for each 100 to 125 pullets.

### Culling for Production

The poultry flock today does not require as much culling as was once recommended. Present breeding and feeding programs and the large expense of raising pullets has the poultryman taking a second look at the birds before selling them in advance of the end of the laying year.

Culling can follow a three stage program: (1) Cull the pullets when they go into the house. Take out only extremely undersized, crippled and diseased birds at this time. Give the birds a chance to come into production. (2) After the flock reaches 60 or 70 per cent production it is ready for the second phase of the culling program. At



**CULL**

**KEEP**

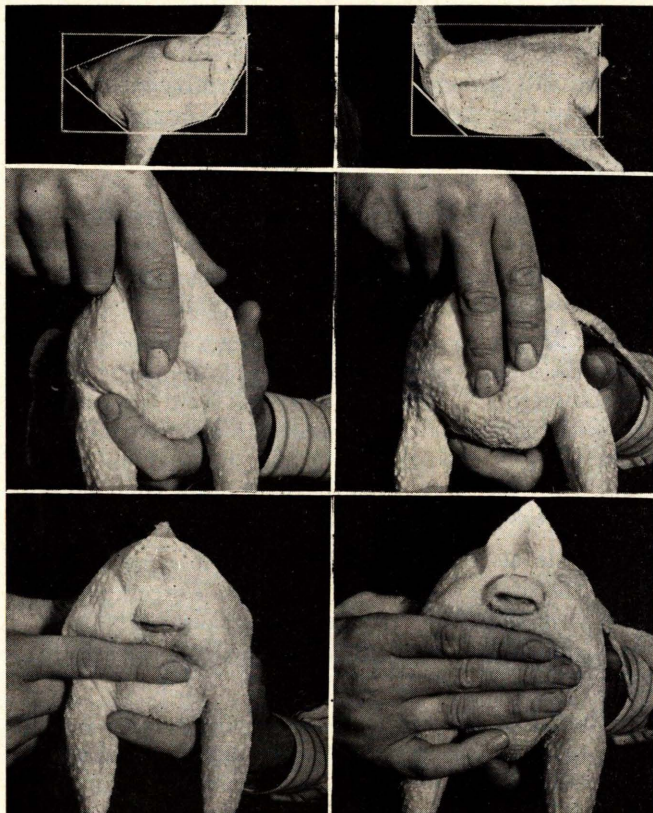

Fig. 12. These dressed birds illustrate what we are looking for in live birds when culling. It is necessary to handle the birds to do a proper job. Keep the bird that has a body like the bird in the pictures at right. She has a long and deep body, at least two finger spread between the pubic or pin bones and three fingers spread between the pin bones and keel bone. Her vent is large and moist. Her abdomen is loose and pliable. The hen on the left is a cull, she has a short shallow body, only one finger spread between pin bones and one finger spread between the pin bones and keel bone. Her vent is puckered and dry. Her abdomen is firm and hard. She is not in laying condition.

this time all non-producers should be culled from the flock. From this point until late spring only sick or crippled birds should be removed from the flock—even if the flock goes through a short winter pause. (3) During the late spring and summer the flock is ready for the third phase of the culling program. During this time birds that are going into the regular annual molt and out of production should be removed as soon as spotted. Diseased and cripples should also be removed whenever discovered.

A good layer will have a large red and waxy comb, bleached or bleaching beak, a bright and prominent eye, and a neat and refined head. Her body will be wide and deep and her vent moist and bleached. She will have a spread of at least two fingers between the pin bones and three or four fingers up and down between the pin bones and keel. Her abdomen will be soft and pliable.

Poor layers or non-layers will have dry and shrunken combs, yellow beaks, dull and sunken eyes and a snaky narrow head. They will have narrow, shallow bodies. The abdomen is hard and pinched together with only a one-finger spread between the pin bones and one- or two-fin-

ger spread up and down between the pin bones and keel bone. The vent will be small and yellow.

Diseased birds should be removed from the flock and disposed of by burning or burying where dogs or wild animals will not dig them up.

Cull birds can be placed in the broody coop and held there until it is convenient to send them to market. For more detail on culling see S. D. Extension Circular No. 534, *Culling the Egg Production Flock*.

**Care of the Broody Hen**

Broody hens should be taken from the nest and placed in a wire or slat-bottomed coop for a few days. Keep in mind a hen that goes broody is a laying hen and should be salvaged if she can be broken of her broody spell without too much trouble.

Feed and water the broody hen just as you would a laying hen and she will go back to laying when she ceases to be broody.

Put a band on her leg, clip her tail or use some other method of identification when the hen goes into the broody coop. If she goes broody again soon after she is broken up she should be culled from the flock and marketed. Individual laying cages make a good broody coop.

**Watch for Cannibalism**

Cannibalism or picking is quite common in flocks soon after they are housed. Pullets may rupture when laying oversize eggs. The rest of the birds will pick the exposed flesh and kill the bird. Once a flock starts picking it is hard to stop them unless drastic measures are taken.

Probably the most practical method of stopping picking in a flock is to debeak the birds with an electric de-beaker. Take about half of the upper beak off. The cutting

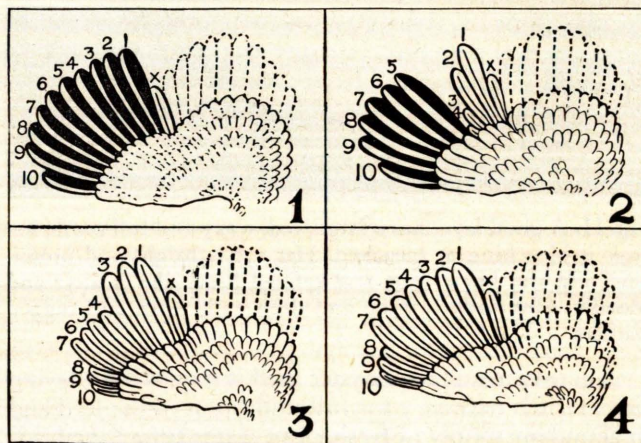

Fig. 13. Start to look for wing molt as early as June. Market the early molters. Diagram of wings at different stages of molt: (1) shows the 10 old primary feathers (black), the secondary feathers (broken outline), separated by the axial feather (x). At six weeks of molt a slow molter, (2), has one fully grown primary, and feathers 2, 3, and 4 are developing at 2 week intervals. In contrast, a fast molter, (3), has all new feathers. Feathers 1 to 3 were dropped first, now fully developed, feathers 4 to 7 were dropped next, now four weeks old, and feathers 8 to 10 were dropped last, now two weeks old. Two weeks later, (4), feathers 1 to 7 are fully grown. Ten weeks were used to complete the entire molt compared to 24 weeks for a slow molter.



is done with a hot blade that sears over the wound and stops bleeding.

Many poultrymen debeak the pullets when they are housed in the fall.

Feed should be fed in the feeders when birds are debeaked. They will not have difficulty in eating from feeders, and will not be thrown out of production if debeaked when production is high. Some poultrymen are debeaking baby chicks when they start picking and are having good results.

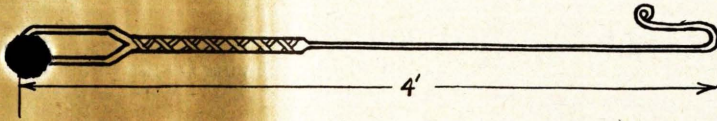

Fig. 14. A chicken hook is a necessary piece of equipment around a poultry flock. Birds can be caught for examination with very little disturbance to the other birds in the pen.

### Egg Production and Marketing

Egg prices generally are higher the last four months of the year. Early chicks, properly managed and fed, will lay at a high rate during these high egg price months.

#### Use Lights for Fall and Winter Production

During the fall and winter, daylight hours are too short. It is necessary to maintain 13 to 14 hours of light per day for the flock to maintain high production. Some use all night lights and smaller bulbs. The time of day the lights are used is not so important as long as the lighting period is uniform. Some poultrymen will turn the lights on in the early morning, some will use evening lights and some will use morning and evening lights. Time switches can be purchased that can be set to turn the lights on or off at any desired time. When using morning or evening lights the length of daylight should be considered and the lights should be turned on and off to correspond with the changing of daylight hours. Caution should be used to keep the lighting period uniform. Forgetting to turn the lights on one or two days in a row may throw a flock into a partial molt and seriously lower the egg production.

#### Produce Clean Eggs

It is easier to produce clean eggs than it is to clean dirty eggs. A properly insulated and ventilated house with deep litter is a big help in producing clean eggs. Gather the eggs often and keep the nest litter clean. Don't let the birds roost on the nests at night. Provide about 1 nest or 1 square foot of nest area for each 4 or 5 hens in a nesting room away from the heavy traffic in the house.

Dropping pits are another aid in producing clean eggs.

Confine the birds to the house. Even with best care and management a few eggs will be slightly soiled. These can be cleaned with steel wool or sandpaper on a block of wood and should be cleaned soon after they are gathered.

#### Gather Eggs Frequently in a Wire Basket

Eggs should be gathered at least three times a day and more often in extremely cold or hot weather. Most of the eggs will be laid by noon. A good schedule for gathering is 9:00 a.m., 12:00 noon, and 4:00 p.m.

The eggs should be placed in a cool, humid place, free

from stale or musty odors, as soon as they are gathered. Ideal temperature and humidity are 40° to 60° F and 70% to 80% humidity. A cool basement or root cellar is probably the most practical place for egg storage on the farm.

Leave the eggs in the wire basket overnight to cool thoroughly and pack them in the cases the following day.

#### Pack Eggs Properly

Always pack eggs point-down in the case. They will deteriorate very rapidly when packed small end up. Sort out odd shape, small, extremely large, cracked and extremely dirty eggs and use them at home. They will not bring top price on the market.

#### Do Not Hold Eggs Too Long

Eggs that are held under ideal conditions should go to market at least once a week. They should be marketed more often if the holding conditions are poor.

#### Feed Affects the Quality of Eggs

Hens fed a uniform balanced ration will produce rather uniform colored yolks. Excessive green feed will darken the yolk and make it less desirable to the consumer who is used to a light yolk. Many people look on dark yolks with suspicion. Inexperienced candlers may place the eggs with dark colored yolks into a lower grade.



Fig. 15. Produce and market clean top quality eggs. Gather and cool the eggs in a wire basket. This allows the air to circulate freely around the eggs and cool them out quickly.

Fig. 16. Pack clean eggs in clean sound cases. Place the flats in the cases with cups up and always place the eggs in the case point down. Do not pack oversize or cracked eggs in cases as they will break and mess up the case during handling. Always cover the cases when marketing.



### Produce Infertile Eggs

Unless you have a breeding flock there is no good reason to keep male birds. They will eat expensive feed and destroy egg quality.

Fertile eggs break down in quality much more rapidly when exposed to heat than do infertile eggs.

### Sell Eggs on Graded Basis when Possible

Good quality eggs are worth more money when sold on grade compared with a current receipt market. Certain times of the year there is a wider margin between top quality and current receipts prices. A person producing good quality eggs should take advantage of a higher price whenever possible.

### Disposition of the Laying Flock

Colleges still recommend that the entire laying flock should be disposed of each year and a new flock of pullets raised.

The old hens potential production is only 70% to 75% of what it was the first year. Egg quality is lower and they are potential disease carriers to the young pullets.

The hens should go to market as soon as they go out of production and start molting in the late spring, summer, or fall. Two weeks to a month before the new pullets are to be housed, the entire flock of old hens should be moved to temporary headquarters or sold so the house can be made ready for the pullets.

### Poultry Diseases

Loss from diseases in a flock can be costly if every effort is not made to keep the flock healthy. Here are four points to consider in protecting the flock from disease.

1. Avoid disease hazards.
  - a. Screen out sparrows and rats.
  - b. Always keep young birds separate from old birds.
  - c. Don't add adult birds from another source to the laying flock.
  - d. Don't allow contaminated equipment in the house.
  - e. Don't let visitors in the poultry house.
  - f. Keep water and feed equipment clean.
  - g. Dispose of dead birds by burning, burying or use of a disposal pit.
2. Birds can be vaccinated for such diseases as Chicken Pox, Laryngotracheitis and Newcastle where necessary.
3. Confine birds to the house.
  - a. Confined birds will stay healthier and will consume a more uniform, balanced diet.
  - b. Overcrowding is one cause of deep litter not working properly.
4. Keep birds free of lice and mites.
  - a. Use a roost spread when lice or mites appear. (1% solution of Lindane is very affective.)

For more detailed discussions on poultry diseases, see USDA FB 1652, "Diseases and Parasites of Poultry," available from your County Extension Agent.

EXTENSION SERVICE, SOUTH DAKOTA STATE COLLEGE OF  
AGRICULTURE AND MECHANIC ARTS,  
BROOKINGS, SOUTH DAKOTA

Published and distributed under Acts of Congress, May 8 and June 30, 1914,  
by the Agricultural Extension Service of the South Dakota State College of  
Agriculture and Mechanic Arts, Brookings, George I. Gilbertson, Director,  
U. S. Department of Agriculture, cooperating.